



FANOX

Safely protected

LOW VOLTAGE GENERAL CATALOGUE

Expertise in Protection Relays



fanox.com

Fanox is a company specialised in the design and manufacture of Electronic Relays for Low and Medium Voltage applications. Since its foundation, back in 1992, Fanox has developed a wide range of products for multiple applications, and as an innovation driver and trendsetter, is settling itself in the energy market as a powerful manufacturer of a large number of Protection Relays that can be used in any kind of application in the Transmission & Distribution Lines.

Fanox Relays has become the safest and most reliable Relays on the market. All our Relays can be adapted to the technical specifications and requirements of customers, obtaining the best technical solution to meet their application and assembly needs.



Our expertise and in-house R+D+i in continuous development and innovation enables us to offer global and complete solutions to each specific application.

Since protection devices have changed so much over the years, it's important to deal with a company who understands exactly what you and your application need. We do.

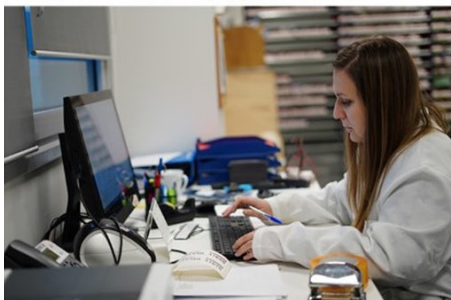
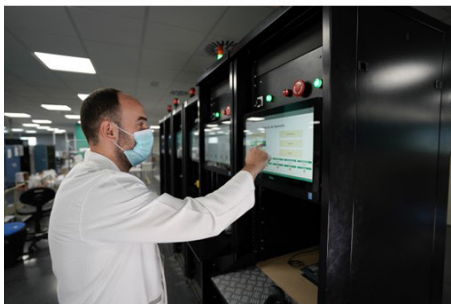

FANOX

Safely protected

Customers and Approvals Worldwide...

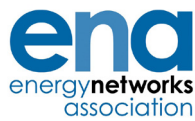



protection & control

Safely protected

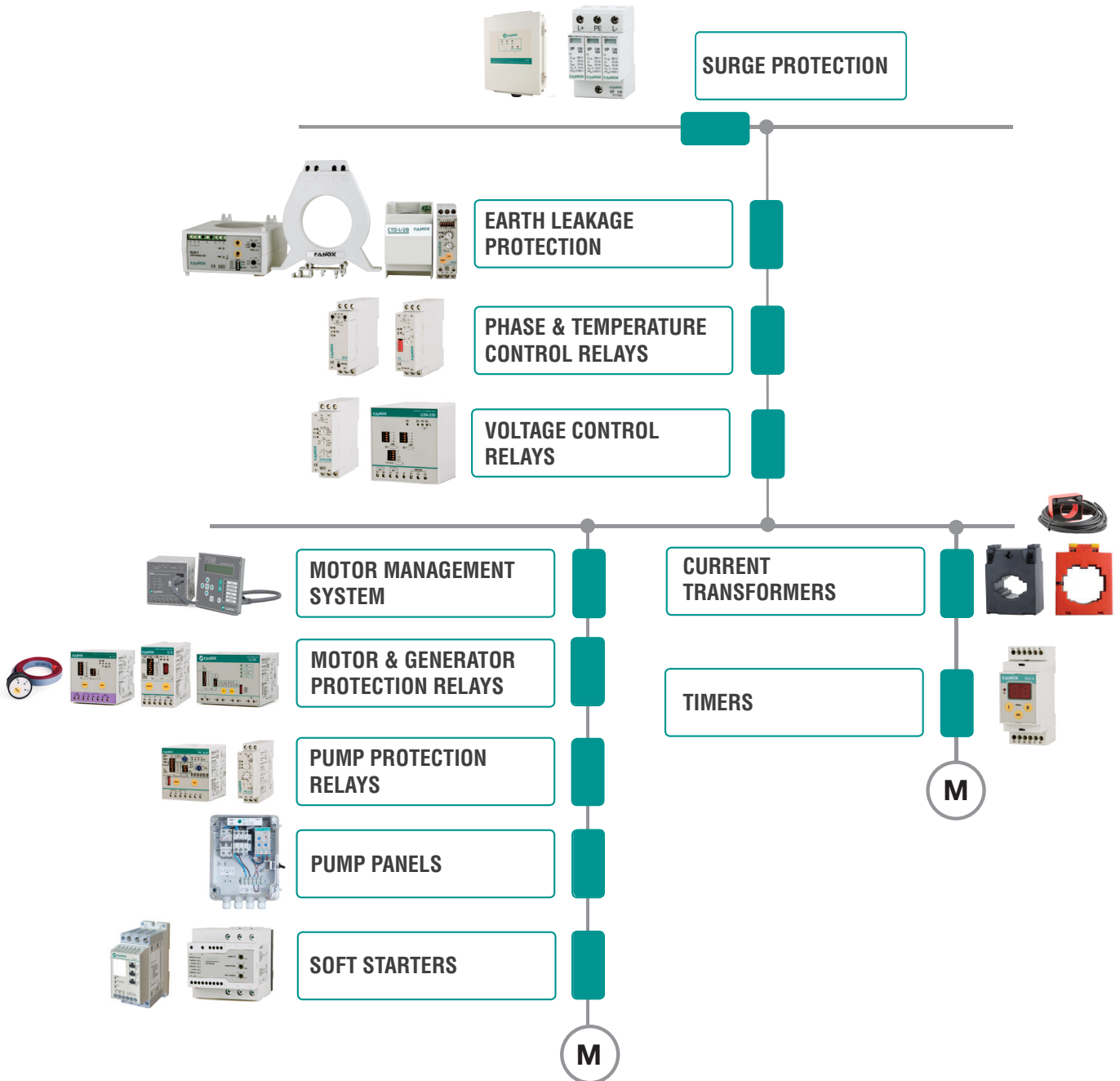

ELECTRONIC PROTECTION & CONTROL OF MOTORS & GENERATORS



Motor Management System

PBM



Integral Motor Protection Relays

GL Series



Basic Motor Protection Relays

C Series



EEX e Motor Protection Relays

G Series



Generator Motor Protection Relays

GEN Series



Soft Starters & Motor Controller

ES Series

ELECTRONIC PROTECTION & CONTROL OF PUMPS

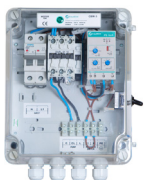

Panels for Submersible Pumps

CBM, CBT & CBS Series



Pump Protection Relays by Undercurrent

PS & P Series



Pump Protection Relays by cosφ

PF Series

CONTROL & MEASUREMENT



Phase & Temperature Control Relays

S, ST & ST-D Series



Phase & Temperature Control Relays (LIFTS)

T2 & TST24 Series



Temperature Control Relay by Thermistors

MT2 Series



Voltage Control Relays

U1 & U3 Series



Timers

MTR10 Series

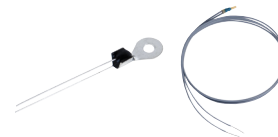

Thermistor Sensors

PTC

EARTH LEAKAGE PROTECTION



Earth Leakage Relays WITH Built-in Toroidal Transformer

ELR-A & ELR-T Series



Earth Leakage Relays WITHOUT Built-in Toroidal Transformer

ELR-B, ELR-3C, D30, DM30 & DR30 Series



Toroidal Transformers

CT-1 & CTD-1

PROTECTION AGAINST TRANSIENT OVERVOLTAGES



Power Supply Systems & Installations

VP Series Class C, B+C & B



Photovoltaic & Wind Application

VP Series Class C



Surge Arresters

SST Series Class B

CUSTOMIZED PRODUCTS AND BRANDLABELING

ELECTRONIC PROTECTION & CONTROL OF MOTORS AND GENERATORS

Introduction

Fanox designs and manufactures the most reliable protection & control relays in the market. Products that efficiently prevent engine burnouts, saving costly repairs and preventing dreaded and unnecessary downtime in any important process.

The electric motor is one of the most important drives in industry, and plays a decisive role in the success of a production process. Valuable production processes and high value machinery can be completely paralyzed by one single motor failure. This poses the risk of great expenses, with the resulting costs significantly exceeding the cost of repairing the motor itself.

Experience shows that motor protection is still a novelty, and still not a priority amongst users. The high numbers of faults that occur every day are mainly due to overloads, locked rotor, phase failure or imbalance, heavy bursts of long duration or high duty cycle of operations, or overheating.

Over 60% of failures are due to causes not detected by conventional protection systems, causing excessive heat in the windings, leading to a drastic reduction of the electrical life of the motor.



The most significant technical advantages of Fanox designed equipment is:

- Continuous Thermal image memory of heating and cooling cycles of the engine's starting cycles, work overload and stoppages.
- The prompt detection of phase loss, even with the engine running at low loads, stopping quickly to avoid costly breakdowns.
- Identification of trip cause. The relays indicate the reason for tripping instantly allowing you to identify and act quickly on faults.











Selection guide

MOTOR MANAGEMENT SYSTEM

MODELS	Adjustment range I_B (A)	MOTOR CHARACTERISTICS 400V		PROTECTION FUNCTIONS						
		HP	kW	$I <$		(R)		JAM		I_g / I_0
PBM B1	0,8 - 6	0,33 - 3	0,25 - 2,2	•	•	•	•	•	•	•
PBM B5	4 - 25	3 - 15	2,2 - 11	•	•	•	•	•	•	•

PROTECTION RELAYS

MODELS	Adjustment range I_B (A)	MOTOR CHARACTERISTICS 400V		PROTECTION FUNCTIONS						
		HP	kW	$I >$	$I <$	$\cos \varphi$		(R)		$U >$
C 9	3 - 9,3	2 - 5,5	1,5 - 4	•			•			
C 21	9 - 21,6	7,5 - 12	5,5 - 9	•			•			
C 45	20 - 45,2	15 - 30	11 - 22	•			•			
GL 16	4 - 16,7	3 - 10	2,2 - 7,5	•			•		•	
GL 40	15 - 40,5	10 - 25	7,5 - 18,5	•			•		•	
GL 90	40 - 91	30 - 60	22 - 45	•			•		•	
GL 200	60 - 200	50 - 150	37 - 110	•			•		•	
PS 11-R	3 - 11	0,5 - 2	0,37 - 1,5	•	•					•
PS 16-R	3 - 16	0,5 - 3	0,37 - 2,2	•	•					•
P 19	7 - 19,6	4 - 10	3 - 7,5	•	•		•	•		
P 44	19 - 44,2	12,5 - 27,5	9,2 - 20	•	•		•	•		
P 90	40 - 90,4	27,5 - 55	20 - 40	•	•		•	•		
PF 16-R	4 - 16,6	3 - 10	2,2 - 7,5	•		•	•	•		
PF 47-R	16 - 47,5	10 - 30	7,5 - 22	•		•	•	•		
G 17	5 - 17,7	3 - 10	2,2 - 7,5	•			•		•	
GEN 10	4 - 10,3	-	-	•			•			

$I >$	$I <$	$\cos \varphi$		(R)		$U > / U <$	\ast I_N		JAM	I_g / I_0
Overload	Undercurrent	Underload	Phase loss Phase imbalance	Phase sequence	Overtemperature	Overvoltage / Undervoltage	Loss of neutral	Locked rotor	JAM	Earth leakage: differential/homopolar

PBM Protection, Control and Monitoring System

MOTOR MANAGEMENT SYSTEM

INTEGRAL SOLUTION FOR MCCs ADAPTABLE TO EVERY CUSTOMER NEEDS

MULTIFUNCTION

FAULT REPORTS

4 fault reports with the following information: dates, measurements, status bits, inputs and outputs.

SELF-DIAGNOSIS, INSTALLATION MONITORING AND STATISTICS

- Earth toroidal disconnection monitoring.
- PTC sensor open circuit and short circuit detection.
- Magnetic module hardware monitoring.
- Non-volatile memory stored information coherence.
- Number of motor start ups.
- Medium and maximum current of last start up.
- Number of faults for the following functions: Overload, PTC, JAM, locked rotor and neutral faults.
- Operating hours counter.
- Test menu.

DESIGNED FOR SCADA APPLICATIONS

RTU Modbus protocol and RS485 communication

COMMANDS MANAGEMENT

- Start/Stop by 2 or 3 wires, without additional switches or push-buttons
- Remote Start/Stop, more efficiency and cost saving.

COMMUNICATION SOFTWARE PBCom

PBM B



PBM H

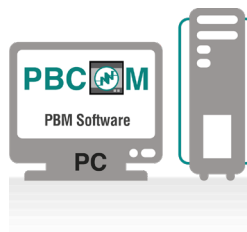

PROTECTION FUNCTIONS

- $I_{>}$ Overload with thermal image
- $I_{>+t}$ Overheating protection (PTC sensor)
- I_{Δ} Phase imbalance or phase failure
- I_{seq} Phase sequence
- JAM** JAM detection
- I_{LR} Locked rotor detection
- $I_{g>}$ Instantaneous earth leakage overcurrent
- $I_{g>}$ Earth leakage inverse time overcurrent
- $I_{0>}$ Instantaneous neutral overcurrent
- $I_{0>}$ Neutral inverse time overcurrent
- $I_{<}$ Undercurrent

PBM B

BASE MODULE

Current measurement is obtained from the motor line through the magnetic module without need of external current transformers.

From 0,8 up to 25 A with internal current transformers.
Over 25 A with external current transformers.

MODELS		PBM-B1		PBM-B5	
		PBM-B11	PBM-B12	PBM-B51	PBM-B52
Adjustment range	lb (A)	0,8-6A	0,8-6A	4-25A	4-25A
Auxiliary supply		110/230Vac-dc	24/48Vdc	110/230Vac-dc	24/48Vdc
Frequency		50/60/ variable (45-65) Hz			
Maximum motor nominal voltage		1.000 Vac			
CODE		17000	17002	17001	17003
For I_N of the motor below the minimum setting I_B		Pass the cables several times (n) through the holes in the relay $I_B = n \times I_N$			
For I_N of the motor above the maximum setting I_B		Use 3 CT .../5 and the relay PBM B and pass the secondary through the holes			
OTHERS CHARACTERISTICS					
Optional		PBM-H display module HMI			
Inputs		1 x PTC temperature sensor, 1 x Toroidal transformer (external earth fault), 1 x Digital input 24 Vdc			
Outputs		2 x NO-NC contact			
Short circuit withstand rating		5000 A to 0,5s (SCR 5000@0,5s)			
Communication		RS485 ModBus RTU			
Signalling		5 signalling LEDs			
Reset mode		Manual, automatic and automatic time delayed			
Test		Specific test menu			
Operating temperature		- 10°C + 60°C			



PBM H

DISPLAY MODULE HMI

This is an optional display module with an LCD screen for signalling, control and setting. The LEDs can be configured and are identified by labels. Access to menus is intuitive and direct, making protection system commissioning easier.

CODE	ACCESORIES	LANGUAGE
17015	PBM - H1S1	Spanish
17016	PBM - H1F1	French
17017	PBM - H1E1	English
17018	PBM - H1P1	Polish
17019	PBM - H1G1	German
79229	CD PBM	
17008	CDCNB CABLE 0,5 M	
17009	CDCN1 CABLE 1 M	

CHARACTERISTICS PBM H	
LCD Display	20 x 2 alphanumeric characters
Keyboard	9 keys
Communication	RJ45 connector to relay
Signalling	6 configurable signalling LEDs
Reset mode	Manual, automatic and automatic time delayed
Test	Specific test menu

FUNCTION DIAGRAM PBM B

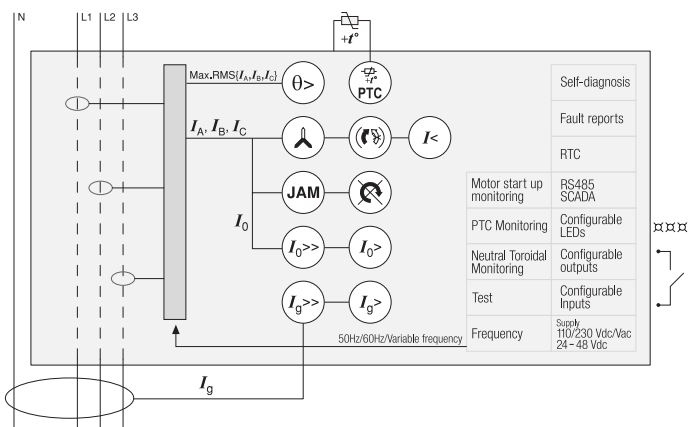

CONNECTION DIAGRAM PBM B

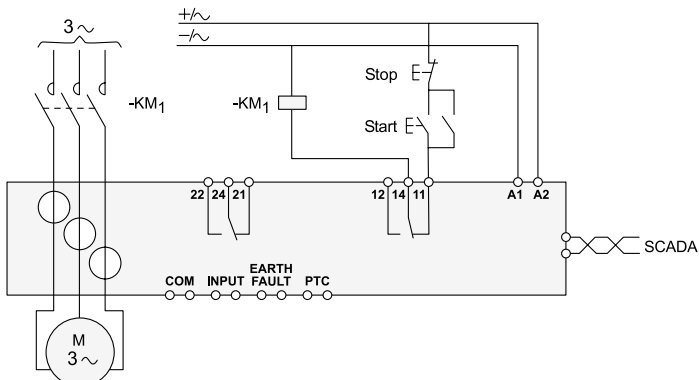

DIMENSIONS (mm)

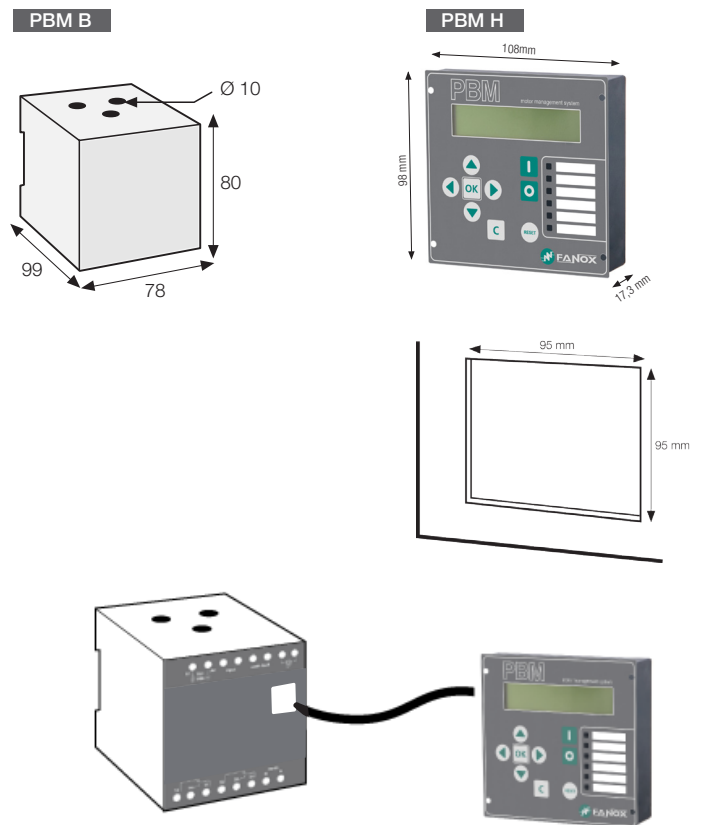

Integral Motor Protection Relays

INTEGRAL MOTOR PROTECTION

- For 3-phase motors from 1 to 630 A and over. Cable feed through relay.
- Precise motor heating and cooling memory, reproduces its thermal image.
- Immediate detection of phase loss (3 s), even at reduced load.
- Visual indication of tripping cause.

For motors (1 to 630 A and over), in applications such as surface mounted pumps, compressors, mixers, ventilators, elevators, cranes, industrial refrigeration and in general for those motors requiring complete protection where over temperature (by means of PTC sensor) and incorrect phase sequence protection is required.

Its 7 trip classes cover all types of starting or working cycles.

EXTERNAL DISPLAY MODULE

By means of this plug-in optional accessory, the relay status can be seen and reset from the exterior of the electrical panel board.

Easy to install. Size of a Ø22 mm push button.

Suitable for motor control centres (MCC) and panel boards.

GL

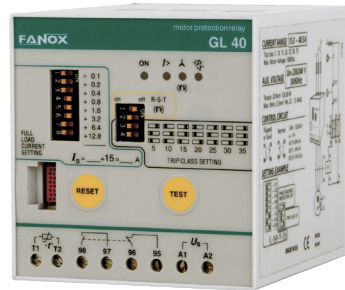

PROTECTION FUNCTIONS

- Overload
- ⚡ Phase imbalance or phase loss
- 🔥 Overtemperature
- ⚡ Phase sequence

ODGL



Models	Code	Relay type
ODGL	12535	GL

MODELS		GL 16	GL 40	GL 90	
Adjustment range	I_B (A)	4 - 16,7	15 - 40,5	40 - 91	
Motor 400 V	CV	3 - 10	10 - 25	30 - 60	
50/60 Hz	kW	2,2 - 7,5	7,5 - 18,5	22 - 45	
Code	according to the relay voltage supply	230 Vac single phase	11303	11323	11343
	(+15% -10%)	115 Vac single phase	11302	11322	11342
	ac: 50/60 Hz	24 Vac, dc single phase	11300	11320	11340
For I_N of the motor below the minimum setting I_B		Pass the cables several times (n) through the holes in the relay $I_s = n \times I_N$			
For I_N of the motor above the maximum setting I_B		Use 3 CT .../5 and the relay GL16 and pass the secondary through the holes			
External display module (optional)		ODGL			

DIMENSIONS GL RELAY (mm)

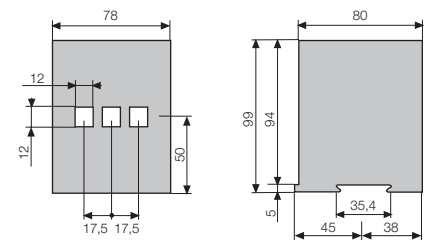

DIMENSIONS ODGL MODULE (mm)

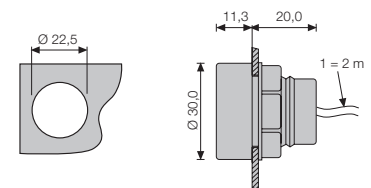

CHARACTERISTICS	
Thermal memory / Overload trip	Yes / From $1,1 \times I_B$
Maximum motor nominal voltage	1000 Vac
Trip classes (IEC 947-4-1)	5 - 10 - 15 - 20 - 25 - 30 - 35
Phase sequence protection	ON <input type="checkbox"/> OFF <input type="checkbox"/> Actuates during the motor start
Phase imbalance protection	Over 40%. Tripping time < 3s
PTC Min/max cold resist. -Average trip / reset resist.	25Ω / 1500Ω - 3600Ω / 1800Ω
Reset mode	Manual and remote
Signalling LED's	4 LED's: ON + $I >$ + Δ + PTC + PS
Output contacts	1 relay with 1 NA + 1 NC
Switching power	I_{th} : 5A; AC15 - 250V - 2A; DC13 - 30V - 2A
Terminals: Max. section / screw torque	2,5 mm ² , No. 22 - 12AWG / 20Ncm, 1.8 LB - IN
Power consumption	2,5 VA (115-230 Vac) - 1,5 W (24 Vdc)
Protection degree / weight / mounting	IP20 / 0,5 kg / DIN rail
Storage temperature	-30°C +70°C
Operating temperature / max. altitude	-15°C +60°C / 1000m ; -15°C +50°C / 3000m
Standards	IEC 255, IEC 947, IEC 801, EN 50081-2



WIRING DIAGRAMS

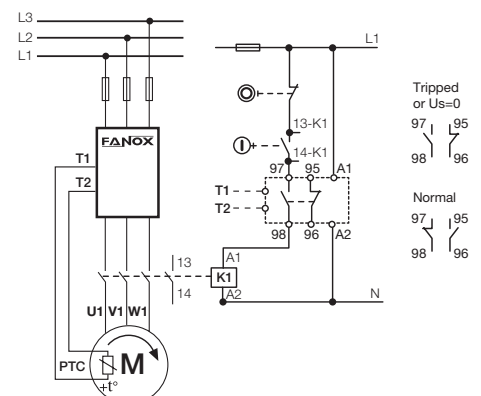

INTEGRAL MOTOR PROTECTION

- For 3-phase motors from 60 to 200 A and over. Cable feed through relay.
- Precise motor heating and cooling memory, reproduces its thermal image.
- Immediate detection of phase loss (3 s), even at reduced load.
- Visual indication of tripping cause.

For 3 phase motors up to 200A, in applications such as surface mounted pumps, compressors, mixers, ventilators, elevators, cranes, industrial refrigeration and in general for those motors requiring complete protection where over temperature (by means of PTC sensor) and incorrect phase sequence protection is required.

Its 7 trip classes cover all types of starting or working cycles.

EXTERNAL DISPLAY MODULE

By means of this plug-in optional accessory, the relay status can be seen and reset from the exterior of the electrical panel board.

Easy to install. Size of a Ø22 mm push button.

Suitable for motor control centres (MCC) and panel boards.

GL 200

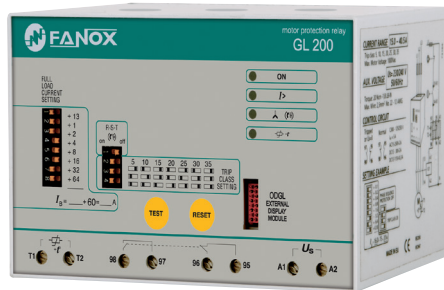

PROTECTION FUNCTIONS

- Overload
- Phase imbalance or phase loss
- Overtemperature
- Phase sequence

ODGL



Models	Code	Relay type
ODGL	12535	GL

MODELS		GL 200	
Adjustment range	I_B (A)	60 - 200	
Motor 400 V	CV	50 - 150	
50/60 Hz	kW	37 - 110	
Code	according to the relay voltage supply	230 Vac	single phase
		115 Vac	single phase
	ac: 50/60 Hz	24 Vac, dc	single phase
External display module (optional)		ODGL	

DIMENSIONS GL RELAY (mm)

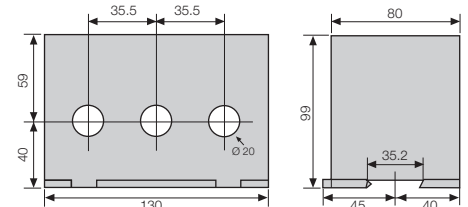

CHARACTERISTICS	
Thermal memory / Overload trip	Yes / From $1,1 \times I_B$
Maximum motor nominal voltage	1000 Vac
Trip classes (IEC 947-4-1)	5 - 10 - 15 - 20 - 25 - 30 - 35
Phase sequence protection	ON <input type="checkbox"/> OFF Actuates during the motor start
Phase imbalance protection	Over 40%. Tripping time < 3s
PTC Min/max cold resist.-Average trip / reset resist.	25Ω / 1500Ω - 3600Ω / 1800Ω
Reset mode	Manual and remote
Signalling LED's	4 LED's: ON + + + +
Output contacts	1 relay with 1 NA + 1 NC
Switching power	I_m : 5A; AC15 - 250V - 2A; DC13 - 30V - 2A
Terminals: Max. section / screw torque	4.0 mm ² , No. 30 - 12AWG / 50Ncm, 4.4 LB - IN
Power consumption	2,5 VA (115-230 Vac) - 1,5 W (24 Vdc)
Protection degree / weight / mounting	IP20 / 1 kg / DIN rail
Storage temperature	-30°C +70°C
Operating temperature / max. altitude	-15°C +60°C / 1000m ; -15°C +50°C / 3000m
Standards	IEC 255, IEC 947, IEC 801, EN 50081-2



WIRING DIAGRAMS

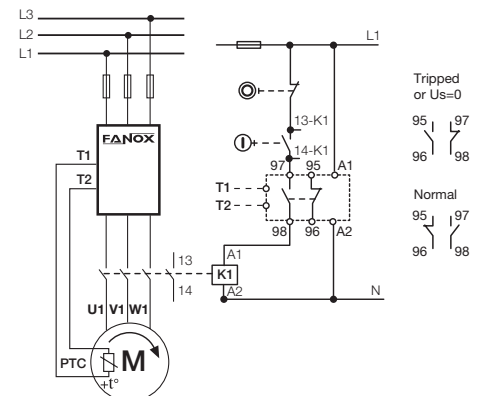

Basic Motor Protection Relays

BASIC MOTOR PROTECTION

- For 3-phase motors from 1 to 630 A and over. Cable feed through relay.
- Precise motor heating and cooling memory, reproduces its thermal image.
- Immediate detection of phase loss (3 s), even at reduced load.
- Visual indication of tripping cause.

For motors of low and medium power in several applications such as compressors, ventilators, surface mounted pumps, conveyor belts, machine tools, and in general to protect motors which need dependable and accurate protection relays for every type of start.

Its 3 trip classes cover many types of starting or working cycles.

EXTERNAL DISPLAY MODULE

By means of this plug-in optional accessory, the relay status can be seen and reset from the exterior of the electrical panel board.

Easy to install. Size of a Ø22 mm push button.

Suitable for motor control centres (MCC) and panel boards.

C

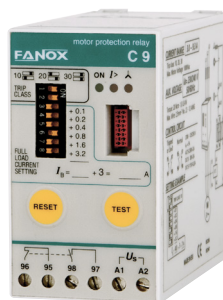

PROTECTION FUNCTIONS

- Overload
- ⚡ Phase imbalance or phase loss

ODC



Models	Code	Relay type
ODC	12530	C

MODELS		C 9	C 21	C 45
Adjustment range	I_B (A)	3 - 9,3	9 - 21,6	20 - 45,2
	CV	2 - 5,5	7,5 - 12	15 - 30
Motor 400 V 50/60 Hz	kW	1,5 - 4	5,5 - 9	11 - 22
	Code			
according to the relay voltage supply (+15% -10%) ac: 50/60 Hz	230 Vac single phase	11203	11223	11243
	115 Vac single phase	11202	11222	11242
	24 Vac, dc single phase	11200	11220	11240
For I_N of the motor below the minimum setting I_B		Pass the cables several times (n) through the holes in the relay $I_s = n \times I_N$		
For I_N of the motor above the maximum setting I_B		Use 3 CT .../5 and the relay C9 and pass the secondary twice through the holes		
External display module (optional)		ODC		

DIMENSIONS C RELAY (mm)

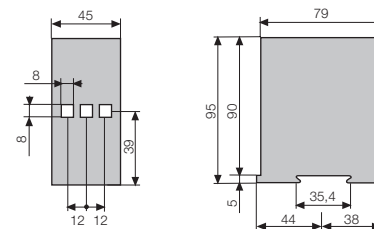

DIMENSIONS ODC MODULE (mm)

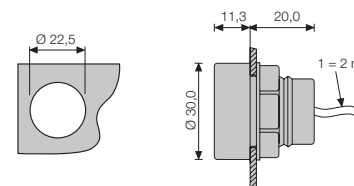

CHARACTERISTICS	
Thermal memory / Overload trip	Yes / From 1,1 x I_B
Maximum motor nominal voltage	1000 Vac
Trip classes (IEC 947-4-1)	10 - 20 - 30
Phase imbalance protection	Over 40%. Tripping time < 3s
Reset mode	Manual and remote
Signalling LED's	3 LED's: ON + I + Δ
Output contacts	1 relay with 1 NO + 1 NC
Switching power	I_{th} : 5A; AC15 - 250V - 2A; DC13 - 30V - 2A
Terminals: Max. section / screw torque	2,5 mm ² , No. 22 - 12AWG / 20Ncm, 1.8 LB - IN
Power consumption	C9 : 6,5VA (230Vac) - 3VA (115Vac) / C21-C45 : 2,5VA
Protection degree / weight / mounting	IP20 / 0,3 kg / DIN rail
Storage temperature	-30°C +70°C
Operating temperature / max. altitude	-15°C +60°C / 1000m ; -15°C +50°C / 3000m
Standards	IEC 255, IEC 947, IEC 801, EN 50081-2

WIRING DIAGRAMS

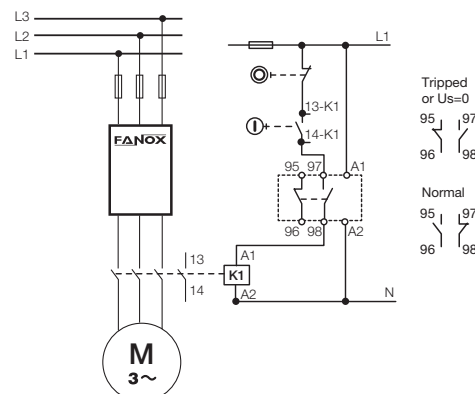

EEx e Motor Protection Relays

MOTOR PROTECTION IN EXPLOSIVE OR HAZARDOUS AREAS

- Certificates for use as category 3 - Directive ATEX 94/9/EC.
- For 3-phase motors up to 1000 Vac.
- Currents from 1,5 to 630 A and over.
- With thermal memory.
- Visual indication of tripping cause.

These relays are applicable for EEx e motors with ratings up to 630A and above, operating in potentially explosive or hazardous areas such as petrochemical industries, plastic factories, etc. The relay is installed outside the explosive area.

PTB approval:

G and BG relays have been approved by the **Physikalisch-Technische Bundesanstalt-PTB** for the protection of EEx e explosion proof motors (DIN EN 50019 / DIN VDE 0170 /DIN VDE 0171 part 6) according to the stipulations and requirements of PTB. PTB report no. PTB Ex 3.43-30004/00.



The models G and BG are ATEX marked with certification for Category 3 use.



G

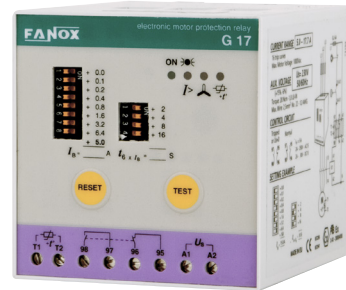

PROTECTION FUNCTIONS

- Overload
- ⚡ Phase imbalance or phase loss
- 🔥 Overtemperature

MODELS		G 17	
Adjustment range	I_B (A)	5 - 17,7	
Motor 400 V	CV	3 - 10	
50/60 Hz	kW	2,2 - 7,5	
Code	according to the relay voltage supply	230 Vac single phase	10723
	(+15% -10%)	115 Vac single phase	10722
	ac: 50/60 Hz	24 Vdc, ac	10720
For I_N of the motor below the minimum setting I_B		Pass the cables several times (n) through the holes in the relay $I_B = n \times I_N$	
For I_N of the motor above the maximum setting I_B		Use 3 CT's .../5 and pass their secondary twice (n=2) through the relay holes	
External display module / Code no.		No	

DIMENSIONS G RELAY (mm)

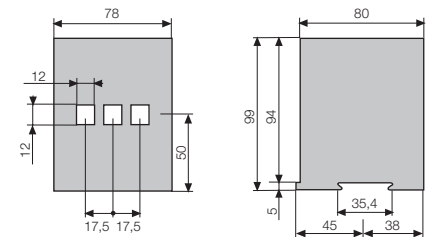

WIRING DIAGRAM

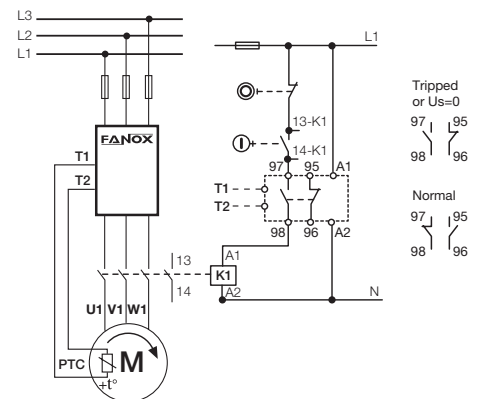

CHARACTERISTICS	
Thermal memory / Overload trip	Yes / From $1,1 \times I_B$
Maximum motor nominal voltage	1000 V
15 adjustable tripping curves	Cold tripping times at $6 \times I_B$ from 2 to 30s
Phase imbalance protection	Over 40%. Tripping time < 3s
PTC min/max cold resist. / Average trip resistance	100 Ω / 1500 Ω - 2750 Ω
Reset mode	Manual and remote
Signalling LED's	4 LED's: ON + one for each protection
Single-phase auxiliary power supply	<ul style="list-style-type: none"> • Voltage U_s • Frequency • Consumption • Protection fuse
Output contacts	1 relay with 1 NO + 1 NC I_{th} : 5A; AC15 - 250V - 2A; DC13 - 30V - 2A 1000 A
Short circuit withstand rating	5000 A at 0,5 s (SCR 5000@0,5 s)
Terminals max. section / Screw torque	2,5 mm ² , No. 22 - 12AWG / 20Ncm, 1,8 LB - IN
Protection degree / weight / mounting	IP20 / 0,5 kg / DIN rail
Storage temperature	-30°C +70°C
Operating temperature	-15°C +60°C
Standards	EN 50081-2, EN 61000-4-2, EN 61000-4-3, EN 61000-4-4, EN 60529, EN 60947-5-1, UL 508 EN 60947-1, EN 60947-4-1, EN 60255-8, EN 954-1, EN 60079-14, EN 60034-1, EN 50019



Generator Protection Relay

GENERATOR PROTECTION

- For generators up to 1000 Vac.
- With thermal memory.
- Visual indication of trip cause.
- Fast trip curves.

This relay is specially applicable for protecting low voltage generators up to 1000 Vac, and currents up to 2000 A or higher. Precise motor heating and cooling memory, reproduces its thermal image.

It offers a suitable protection offering the choice between 15 trip curves thus avoiding the generator working over its damage curve.

EXTERNAL DISPLAY MODULE

By means of this plug-in optional accessory the relay status can be seen and reset from the exterior of the electrical panel board.

Easy to install. Size of Ø22 mm push button.

OTHER RELAYS FOR GENERATORS:

- **U3N:** Three-phase voltage relay (See page 119).

GEN

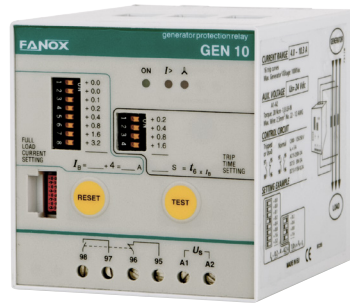

PROTECTION FUNCTIONS

- Overload
- ⚡ Phase imbalance or phase loss

ODGEN



Models	Code	Relay type
ODGEN	12545	GEN

MODELS	GEN 10
Adjustment range I_b (A)	4 - 10,3
Auxiliary voltage supply (+15% -10%)	24 Vdc
Code	11350
For I_N of the generator above 10,3 A	Use 3 current transformers.../5
External display module (optional)	ODGEN

DIMENSIONS GEN RELAY (mm)

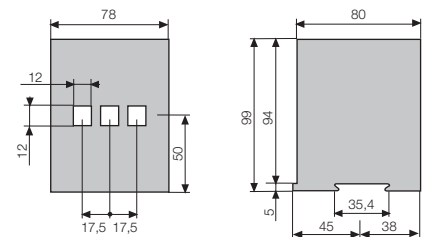

DIMENSIONS ODGEN MODULE (mm)

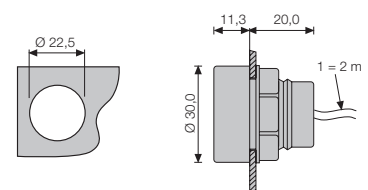

WIRING DIAGRAM

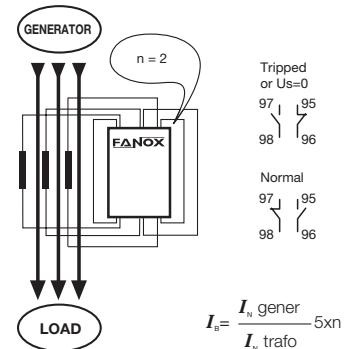

CHARACTERISTICS	
Thermal memory / Overload trip	Yes / From $1,1 \times I_b$
Maximum generator nominal voltage	1000 Vac
Trip time $t_6 \times I_b$	15 adjustable curves from 0,2 to 3 s.
Phase imbalance protection	Over 20%. Tripping time < 3s
Reset mode	Manual and remote
Signalling LED's	3 LED's: ON + one for each protection
Output contacts	1 relay with 1 NO + 1 NC
Switching power	I_{th} :5A; AC15 - 250V - 2A; DC13 - 30V - 2A
Short circuit withstand rating	5000 A at 0,5 s (SCR 5000@0,5 s)
Terminals: Max.section / screw torque	2,5 mm ² , No. 22 - 12AWG / 20Ncm, 1,8 LB - IN
Power consumption	1,5 W
Protection degree / weight / mounting	IP20 / 0,5 kg / DIN rail
Storage temperature	-30°C +70 °C
Operating temperature / max. altitude	-15°C +60°C / 1000m; -15°C +50°C / 3000m
Standards	IEC 255, IEC 801, EN 50081-2



Soft Starters and Motor Controller

- For three-phase induction motors of up to 22 kW / 400 V.
- Built in heat dissipater and electro-mechanical bypass relay.
- Substitutes the conventional contactors. One in direct start-up and three in star-delta start-up cycle. Offers greater life cycle.
- Lower maintenance cost.
- No pressure surge when using pumps and compressors. Reduces hammering.
- Less current and voltage drop during start up. Allows for reduced power consumption.
- Mechanical dimensioning can be optimised.
- Simplified automation.
- Assembly, setting, installation, commissioning and maintenance are made easy by the compact design.
- Reduces start and stop torque, eliminating mechanical problems.
- Additional cooling is not necessary thanks to the bypass built-in relay.
- Substitutes the conventional contactors: one for direct start-up and three for star-delta start-up Δ .

ES-3

ES-12



ES-25

ES-45



PROTECTION FUNCTIONS

- Soft start
- Soft stop

ES -25 and ES -45 model include:

- Phase imbalance or phase loss
- Overtemperature
- Phase sequence
- Overvoltage
- Undervoltage
- Overfrequency
- Overfrequency
- Overcurrent
- Long ramp

MODELS*	ES 400-3	ES 230-12	ES 400-12	ES 230/400-25E	ES 230/400-45E	ES 230/400-25F	ES 230/400-45F
Nominal voltage 50/60 Hz $V \pm 15\%$	400	230	400	220-400	220-400	220-400	220-400
Maximum current A	3	12	12	25	45	25	45
Motor power	kW	1,1	3	5,5	5,5/11	11/22	5,5/11
	CV	1,5	4	7,5	7,5/15	15/30	7,5/15
Code	41803	41801	41812	41825-E	41845-E	41825-F	41845-F

Other voltages available upon request. (380V, 480V and 600V)

CHARACTERISTICS	A1-A2=24-100 Vac,dc / A1-A3=110-480 Vac		A1-A2=110-400 Vac	A1-A2=24 Vac/dc
Control voltage ($\pm 15\%$)				
Degree of protection	IP20			
Operating temperature	-20°C +50°C		-20°C +60°C	
Standards and approvals	IEC947-4-2 UL, CSA and CE mark			

INDICATIONS						
Supply		green	POWER ON	green	POWER ON	green
Ramps		yellow	RAMPING	yellow	RAMPING	yellow
Bypass relay		yellow	BYPASS	yellow	BYPASS	yellow
Alarm			OVERHEAT	red	OVERHEAT	red

ADJUSTMENTS				
Start torque (% of nominal torque)	0 - 85%		0 - 70%	
Start-up time	0,5 - 5 s		1 - 10 s	
Stop time	0,5 - 5 s		1 - 30 s	

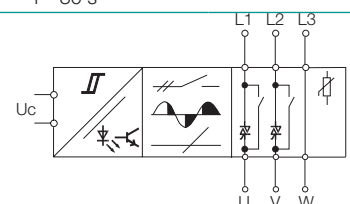
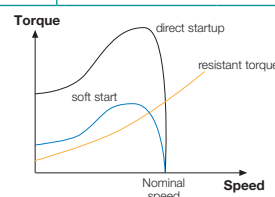
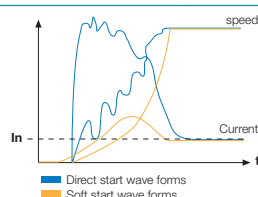

OPERATION

These units represent the best protection against premature ageing of motors and mechanical items.

Sudden starts and stops, that can produce damages in the bearings and gears of the motors, are eliminated.

They prevent frequent faults and objects falling onto conveyer belts.

They reduce mechanical impact in motors, axles, gears and belts, significantly prolonging the operating life of the controlled units.

An electronic circuit with semiconductors starts the motor without using the contacts. Hence these do not withstand sparks or erosion.

When the minimal voltage of the motor is reached the semiconductors are bypassed by the relay contacts. Thanks to this technology, the ES starters have a longer operating life than conventional contactors.

They are easy to install and control. They can operate by means of an external control signal, such as a programmable automation.

POTENTIOMETER SETTING

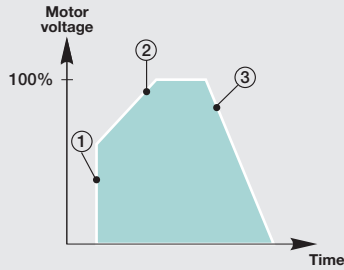

- ① Par: INITIAL TORQUE.
Voltage when ramp-up begins.
- ② Ramp up time: RAMP UP.
- ③ Ramp-down time: RAMP DOWN.

Potentiometers ① ② and ③

- Initially set potentiometers ② and ③ to maximum.
- Connect the supply and set potentiometer ① so that the motor begins to rotate as soon as the supply is applied.
- Set the ramp-up and ramp-down times to the desired value.

MODE OF OPERATION

a) Change from on line direct start to soft start:

- 1) Cut off the cable from the motor and insert the ES starter.
- 2) Connect the control input to two of the input lines. Set the potentiometers according to the settings mode.
- 3) Reconnect the power supply.

On connecting C1, the starter performs a soft motor start. On disconnecting C1, the motor stops, the starter resets to zero and after 0.5 seconds a new soft start up may be performed.

b) Soft Start / Soft Stop

When S1 is closed (connection diagram), the soft motor start is realised according to the potentiometers setting of initial t and % torque.

When S1 is open the soft stop is done in accordance with the ramp down potentiometer setting.

APPLICATIONS

For three-phase motors in applications such as:

- Pumps.
- Cold compressors.
- Conveyor belts, lifting devices, etc.
- Mixers.
- Fans, extractor fans and blowers.
- Garage doors and elevators.
- Concrete mixers.
- Palletizer devices, etc.

DIMENSIONS (mm)

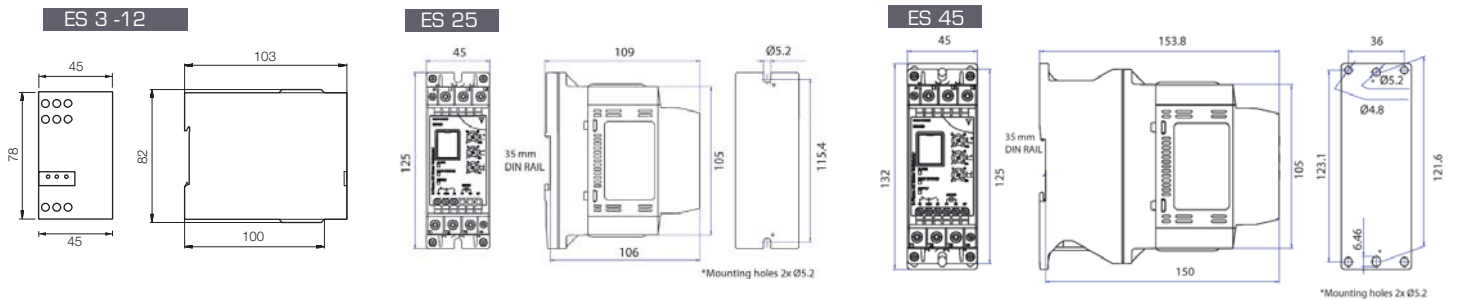

WIRING DIAGRAMS

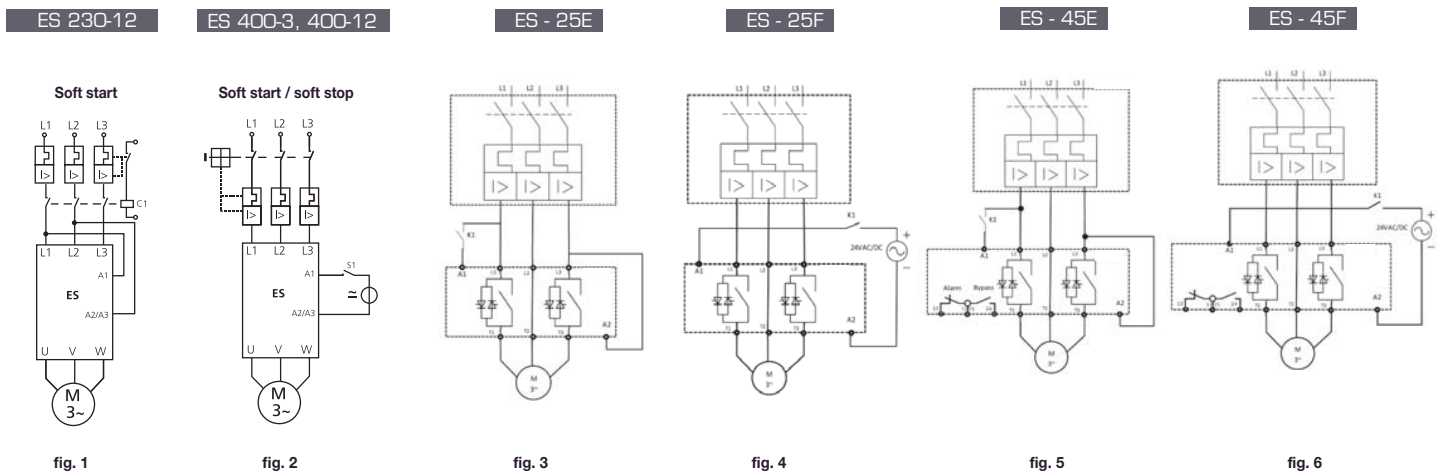

ELECTRONIC PROTECTION & CONTROL OF PUMPS

Introduction

The facts

Submersible pumps must never be in a “dry running” situation to work properly.

This protection function is usually carried out by level electrodes and level relays.

This system is very unreliable, due to the varying amounts of minerals in water, which can lead to rapid damage of level electrodes in water with high mineral levels.

The built-up of sludge or particles on the electrodes, low water conductivity, etc. can also lead to failure in detecting water levels.

Other breakdowns can occur through phase loss or incorrect phase sequence in three-phase pumps or voltage increase in single-phase pumps.

Any of these problems may leave pumps out of service, thus causing the user very significant losses.

The ideal solution...

Fanox control panels for electronic protection of three-phase and single-phase submersible pumps provide a comprehensive solution to these problems by using the motor as a sensor.

They detect the absence of water and act before dry running occurs by measuring the motor's parameters. This is achieved without the need of awkward level electrodes, thus saving time and money in their installation.

They also protect the motor against overload, blocked rotor, overvoltage, phase loss and incorrect phase sequence.

Once the pump has stopped, the control panel waits a certain time (adjustable reset time by the user) before restarting it.

...also suitable for old installations

Faulty level electrodes in an installation that is already operating may mean the costly work of removing the pump from the well, even when it is working properly. In this case, the problem can be solved by replacing the old panel with a Fanox panel, without having to remove the pump.



Panels for SUBMERSIBLE Pumps

SINGLE PHASE PUMPS

- Thermal memory of motors heating and cooling cycles.
- Automatic reset, adjustable from 2 to 240 minutes for well filling,
- Indication of trip cause.
- Control point for pressure switch, buoy, programmer...
- Includes: circuit breaker 1P+N, PS-R electronic relay, contactor, LEDs and on/off switch.

One of the most critical situations in pump operation is dry running. The solution offered by FANOX single-phase protection panels is based on measuring the undercurrent. In dry running situations a current decrease is detected. This reduction of consumed current is measured by the PS-R electronic relay fitted to the protection panel: when the preset undercurrent value is reached, it switches the pump off.

- IP 55
- Plastic case.

WITHOUT LEVEL SENSORS

CBM

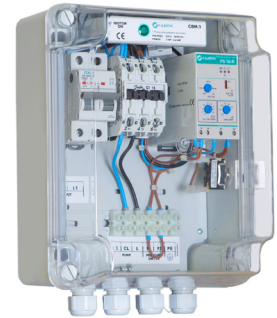
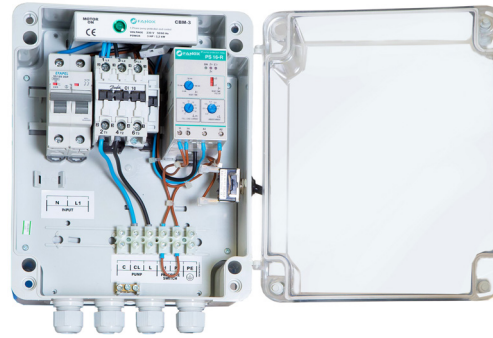

PROTECTION FUNCTIONS

- I> Overload
- I< Undercurrent
- U> Overvoltage
- I>> Short-circuit



Pump protection without level sensor video demo:

Ref.	Code 230V	Adjustable well filling time (min)	I _b (A)	Motor		Protections - Functions				
				HP	kW	I>	I<	U>	Short circuit	Dimensions
CBM-1/P	12311P-230	2 - 70	1 - 5	0,17 - 0,9	0,12 - 0,67	✓	✓	✓	✓	230x250x150
CBM-2/P	12312P-230	2 - 70	3 - 11	0,5 - 2	0,37 - 1,5	✓	✓	✓	✓	230x250x150
CBM-3/P	12314P-230	2 - 240	3 - 16	2 - 3	1,5 - 2,2	✓	✓	✓	✓	230x250x150
CBM-4/P	12313P-230	2 - 75	16 - 28	3 - 5	2,2 - 3,75	✓	✓	✓	✓	230x250x150

• Equipment with halogen-free wiring

Fanox Control Panels protect pumps against dry running without using level sensors.

- Maximum protection without level electrodes or level relays.
- Electronic relay incorporated.
- Quick and easy installation, maintenance-free.
- Installation costs are significantly reduced.
- Can be adapted to installations already in service, without removing the pump.

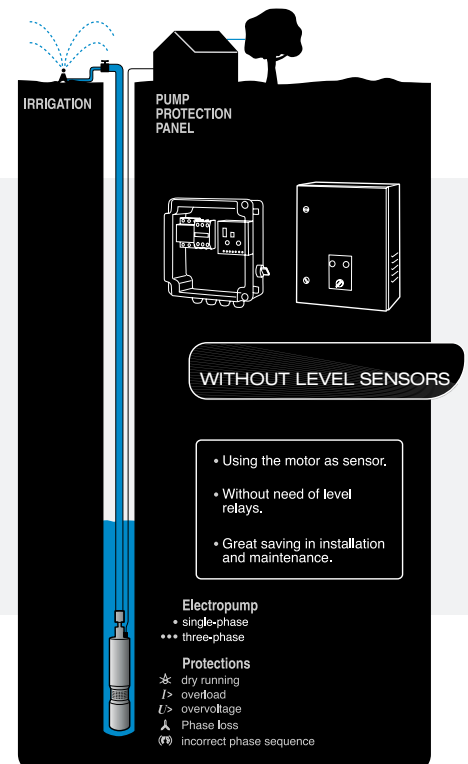

Panels for SUBMERSIBLE Pumps

THREE PHASE PUMPS

- Thermal memory of motors heating and cooling cycles.
- Automatic reset for well filling. Adjustable from 2 to 75 minutes.
- Trip cause indication.
- Control point for pressure switch, buoy, programmer...
- Includes: circuit breaker 3P or 3P+N, PF-R electronic relay, contactor, LEDs and on/off switch.
- Models with plastic case. Also include voltmeter, ammeter and φ meter.

The cosine of phi (Cos φ) is the value of the cosine of the phase angle between the voltage and the intensity of the electrical current. This oscillates from a value slightly below 1 for a full load operating motor to almost 0 when it is dry running.

Therefore, in dry running situations, cos φ falls significantly. This reduction is monitored by the PF-R relay installed in FANOX three-phase protection panels, meaning that when it falls beneath the adjusted value, the panel shuts down the pump and protects it from damage.

- IP 55

WITHOUT LEVEL SENSORS

CBT

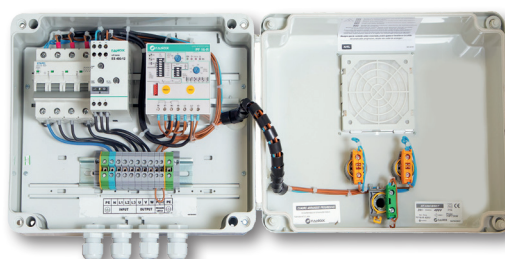

PROTECTION FUNCTIONS

- cos φ Underload
- I> Overload
- Phase imbalance or phase loss
- (R) Phase sequence
- I>> Short-circuit

Ref.	Code		Adjustable well filling time (min)	Ib (A)	Motor		Protections - Functions					
	230V	400V			HP	kW	I>	cos φ	(R)	Short circuit	Phase imbalance or phase loss	Dimensions
CBT-1/P	12301P-230		2 - 75	2 - 6,8	0,5 - 1,5	0,37 - 1,12	✓	✓	✓	✓	✓	230x250x150
CBT-2/P	12302P-230		2 - 75	6,8 - 9,6	1,5 - 2	1,12 - 1,5	✓	✓	✓	✓	✓	230x250x150
CBT-3/P	12303P-230		2 - 75	9,6 - 15,6	2 - 3	1,5 - 2,2	✓	✓	✓	✓	✓	230x250x150
CBT-5/P	12305P-230		2 - 75	15,6 - 22	3 - 5,5	2,2 - 4	✓	✓	✓	✓	✓	230x250x150
CBT-7/P	12307P-230		2 - 75	22 - 28	5,5 - 7,5	4 - 5,5	✓	✓	✓	✓	✓	230x250x150
CBT-10/P	12310P-230		2 - 75	28 - 37	7,5 - 10	5,6 - 7,5	✓	✓	✓	✓	✓	230x250x150
CBT-15/P	12315P-230		2 - 75	37 - 42	10-15	7,5 - 11	✓	✓	✓	✓	✓	230x250x150
CBT-20/P	12316P-230		2 - 75	42 - 56	15 - 20	11 - 15	✓	✓	✓	✓	✓	300x400x220
CBT-25/P	12317P-230		2 - 75	56 - 68	20 - 25	15 - 18,5	✓	✓	✓	✓	✓	300x400x220
CBT-30/P	12318P-230		2 - 75	68 - 80	25 - 30	18,5 - 22	✓	✓	✓	✓	✓	400x600x200
CBT-1/P		12301P-400	2 - 75	1,1 - 2	0,5 - 1	0,37 - 0,75	✓	✓	✓	✓	✓	230x250x150
CBT-2/P		12302P-400	2 - 75	2 - 3,8	1 - 2	0,75 - 1,5	✓	✓	✓	✓	✓	230x250x150
CBT-3/P		12303P-400	2 - 75	3,8 - 8,5	2 - 4,5	1,5 - 3,3	✓	✓	✓	✓	✓	230x250x150
CBT-5/P		12305P-400	2 - 75	8,5 - 9,5	4,5 - 5,5	3,3 - 4	✓	✓	✓	✓	✓	230x250x150
CBT-7/P		12307P-400	2 - 75	9,5 - 13	5,5 - 7,5	4 - 5,5	✓	✓	✓	✓	✓	230x250x150
CBT-10/P		12310P-400	2 - 75	16,5	10	7,5	✓	✓	✓	✓	✓	230x250x150
CBT-15/P		12315P-400	2 - 75	16,5 - 24	10 - 15	7,5 - 11	✓	✓	✓	✓	✓	230x250x150
CBT-20/P		12316P-400	2 - 75	24 - 32	15 - 20	11 - 15	✓	✓	✓	✓	✓	300x400x220
CBT-25/P		12317P-400	2 - 75	32 - 40	20 - 25	15 - 18,5	✓	✓	✓	✓	✓	300x400x220
CBT-30/P		12318P-400	2 - 75	40 - 47	25 - 30	18,5 - 22	✓	✓	✓	✓	✓	400x600x200
CBT-40/P		12319P-400	2 - 75	47 - 64	30 - 40	22 - 30	✓	✓	✓	✓	✓	400x600x200
CBT-50/P		12320P-400	2 - 75	64 - 79	40 - 50	30 - 37	✓	✓	✓	✓	✓	400x600x200
CBT-60/P		12332P-400	2 - 75	79 - 92	50 - 60	37 - 45	✓	✓	✓	✓	✓	400x600x200

- Equipment with halogen-free wiring

Panels for SUBMERSIBLE Pumps

THREE PHASE PUMPS WITH SOFT STARTER

- Thermal memory of motors heating and cooling cycles.
- Automatic reset for well filling. Adjustable from 2 to 75 minutes.
- Trip cause indication.
- Control point for pressure switch, buoy, programmer...
- Plastic case.
- Includes: circuit breaker 3P+N, PF-R electronic relay, ES soft starter, contactor, LEDs and on/off switch.
- IP 54

FANOX protection panels with progressive startup and shut-down are fitted with ES soft starters to prevent problems caused by water hammering or sudden start-ups and shut-downs.

Protection against dry running is provided by the PF-R relay that monitors the value of $\cos \varphi$ and shuts down the pump when it falls below the selected value.

WITHOUT LEVEL SENSORS

CBS

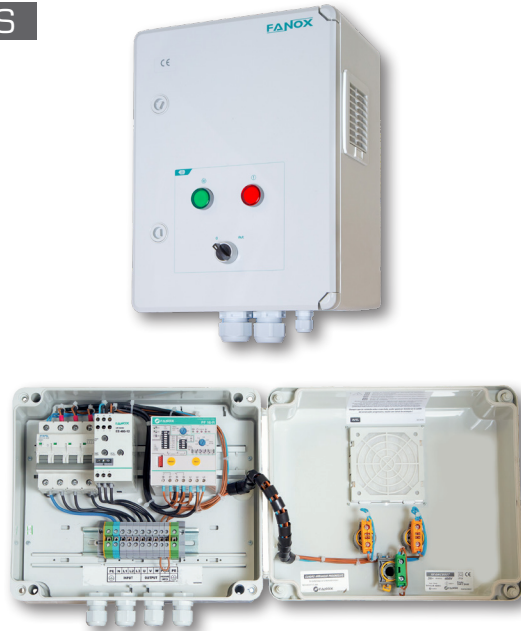

PROTECTION FUNCTIONS

- $\cos \varphi$ Underload
- $I >$ Overload
- Δ Phase imbalance or phase loss
- (R) Phase sequence
- $I >>$ Short-circuit
- \sim Soft start
- \sim Soft stop

Ref.	Code		Adjustable well filling time (min)	I _b (A)	Motor		Protections - Functions						Dimensions
	230V	400V			HP	kW	I >	cos φ	(R)	Soft start/stop	Short circuit	Δ	
CBS-2/P	12321P-230		2 - 75	2 - 6,8	0,5 - 2	0,37 - 1,5	✓	✓	✓	✓	✓	✓	300x250x140
CBS-3/P	12322P-230		2 - 75	9,6	3	2,2	✓	✓	✓	✓	✓	✓	300x250x140
CBS-5/P	12323P-230		2 - 75	12,4 - 15,6	4 - 5,5	3-4	✓	✓	✓	✓	✓	✓	300x250x140
CBS-7/P	12324P-230		2 - 75	22	7,5	5,5	✓	✓	✓	✓	✓	✓	300x250x140
CBS-10/P	12326P-230		2 - 75	28	10	7,5	✓	✓	✓	✓	✓	✓	300x400x200
CBS-12/P	12327P-230		2 - 75	37	12,5	9,2	✓	✓	✓	✓	✓	✓	300x400x200
CBS-15/P	12328P-230		2 - 75	42	15	11	✓	✓	✓	✓	✓	✓	300x400x200
CBS-2/P		12321P-400	2 - 75	3,8	2	1,5	✓	✓	✓	✓	✓	✓	300x400x200
CBS-3/P		12322P-400	2 - 75	5,5	3	2,2	✓	✓	✓	✓	✓	✓	300x400x200
CBS-5/P		12323P-400	2 - 75	7-9,5	3,5 - 5,5	2,6 - 4	✓	✓	✓	✓	✓	✓	300x400x200
CBS-7/P		12324P-400	2 - 75	13	7,5	5,5	✓	✓	✓	✓	✓	✓	300x400x200
CBS-10/P		12326P-400	2 - 75	16,5	10	7,5	✓	✓	✓	✓	✓	✓	300x400x200
CBS-12/P		12327P-400	2 - 75	21	12,5	9,2	✓	✓	✓	✓	✓	✓	300x400x200
CBS-15/P		12328P-400	2 - 75	24	15	11	✓	✓	✓	✓	✓	✓	300x400x200
CBS-20/P		12329P-400	2 - 75	32	20	15	✓	✓	✓	✓	✓	✓	300x400x200
CBS-25/P		12330P-400	2 - 75	40	25	18,5	✓	✓	✓	✓	✓	✓	300x400x200
CBS-30/P		12331P-400	2 - 75	47	30	22	✓	✓	✓	✓	✓	✓	300x400x200

- Equipment with halogen-free wiring
- Other voltages under request

SINGLE PHASE Pump Protection Relay without Level Sensors

SINGLE PHASE PUMP PROTECTION

Underload protection by undercurrent

- Eliminates need for level sensors to detect dry running.
- For 1-phase motors from 3 to 16 A.
- Precise motor heating and cooling memory, reproduces its thermal image.
- Visual indication of trip cause.
- Adjustable reset time for $I<$.

Suitable for 1-phase submersible pumps. By monitoring undercurrent it avoids problems caused by dry running, cavitation, etc.

The great advantage of the PS relay is that, without requiring any external detectors like level electrodes, it monitors the load of the motor and stops it before an expensive breakdown occurs.

PS 11-R



PROTECTION FUNCTIONS

- $I>$ Overload
- $I<$ Undercurrent
- $U>$ Overvoltage

WITHOUT LEVEL SENSORS

PS 16-R

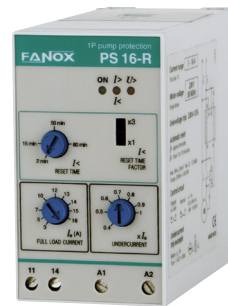

MODELS		PS 11-R	PS 16-R
Adjustment range	I_B (A)	3 - 11	3 - 16
Motor 400 V	CV	0,5 - 2	0,5 - 3
50/60 Hz	kW	0,37 - 1,5	0,37 - 2,2
Code	according to the relay voltage supply		
	230 Vac single phase	12164	12163
	(+15% -10%)		
ac: 50/60 Hz	115 Vac single phase	12171	12172

CHARACTERISTICS	
Thermal memory / Overload trip	Yes / From $1,1 \times I_B$
Maximum motor nominal voltage	230 Vac
Trip classes (IEC 947-4-1)	10
Undercurrent protection adjustable / Trip delay	From 0,4 to $0,9 \times I_B / 5$ s
Overvoltage protection	From nominal V + 15%
Reset mode for protection against dry running	$I<$ automatic (adjustable) and remote. More info in page 110
Reset mode for other protection functions	$I>$ automatic and remote, $U>$ automatic. More info in page 110
Signalling LED's	3 LED's: ON + $I>$ $I<$ + $U>$
Output contacts	1 relay with 1 NO
Switching power	I_n : 5A; AC15 - 250V - 2A; DC13 - 30V - 2A
Terminals: Max. section / screw torque	2,5 mm ² , No. 22 - 12AWG / 20Ncm, 1.8 LB - IN
Power consumption	7 VA (230 Vac) - 4 VA (115 Vac) 3 VA (115-230 Vac)
Protection degree / weight / mounting	IP20 / 0,15 kg / DIN rail IP20 / 0,3 kg / DIN rail
Storage temperature	-30°C +70°C
Operating temperature / max. altitude	-15°C +60°C / 1000m; -15°C +50°C / 3000m
Standards	IEC 255, IEC 947, IEC 801, EN 50081-2



DIMENSIONS PS RELAY (mm)

PS 11-R

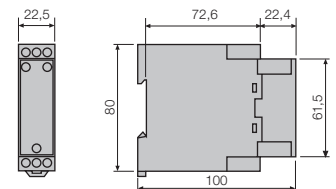

PS 16-R

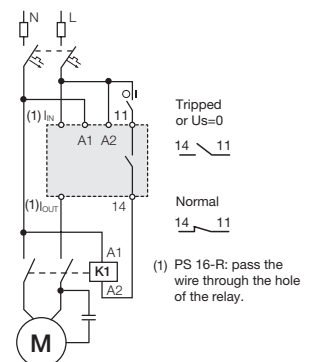
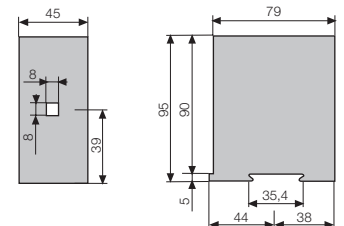

P

THREE PHASE Pump Protection Relay without Level Sensors

THREE PHASE PUMP PROTECTION

Underload protection by undercurrent

- Eliminates need for level sensors to detect dry running.
- For 3-phase motors from 1 to 630 A and over. Cable feed through.
- Precise motor heating and cooling memory, reproduces its thermal image.
- Visual indication of tripping cause.
- Manual, remote and automatic reset.

Suitable where the undercurrent (running without load) is critical, such as submersible pumps, surface pumps, etc. In these cases, when the equipment runs without load (dry well) the relay trips by undercurrent.

The great advantage of the P relay is that, without requiring any external detectors such as level electrodes, it monitors the load of the motor and stops it before an expensive breakdown occurs.

EXTERNAL DISPLAY MODULE

By means of this plug-in optional accessory, the relay status can be seen and reset from the exterior of the electrical panel board.

Easy to install. Size of a Ø22 mm push button.

Suitable for motor control centres (MCC) and panel boards.

P

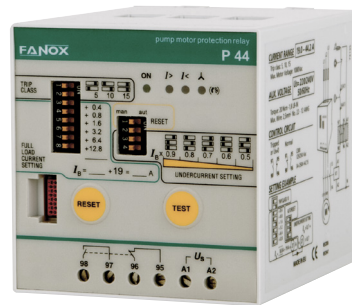

PROTECTION FUNCTIONS

- I> Overload
- I< Undercurrent
- Phase imbalance or phase loss
- Phase sequence

WITHOUT LEVEL SENSORS

ODP



Models	Code	Relay type
ODP	12540	P

MODELS		P 19	P 44	P 90	
Adjustment range	I_B (A)	7 - 19,6	19 - 44,2	40 - 90,4	
	CV	4 - 10	12,5 - 27,5	27,5 - 55	
Motor 400 V	kW	3 - 7,5	9,2 - 20	20 - 40	
	50/60 Hz				
Code	according to the relay voltage supply	230 Vac single phase	11403	11423	11443
	(+15% -10%)	115 Vac single phase	11402	11422	11442
	ac: 50/60 Hz	24 Vac, dc single phase	11400	11420	11440
For I_N of the motor below the minimum setting I_B		Pass the cables several times (n) through the holes in the relay $I_B = n \times I_N$			
For I_N of the motor above the maximum setting I_B		Use 3 CT .../5 and the relay P 19			
External display module (optional)		ODP			

DIMENSIONS P RELAY (mm)

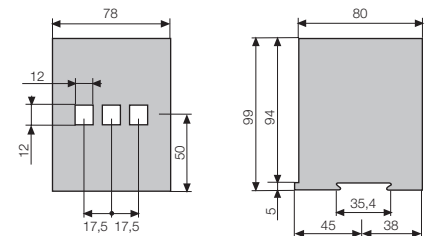

DIMENSIONS ODP MODULE (mm)

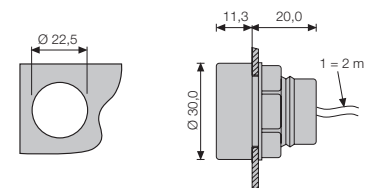

WIRING DIAGRAM

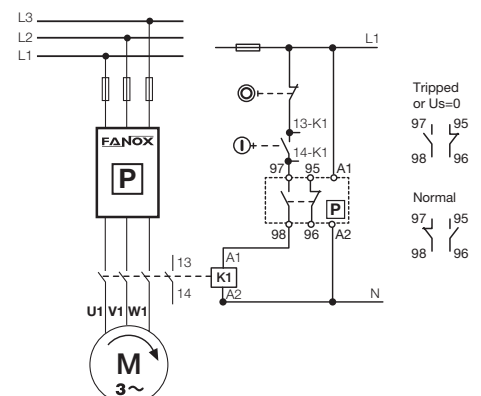

CHARACTERISTICS	
Thermal memory / Overload trip	Yes / From $1,1 \times I_B$
Maximum motor nominal voltage	1000 Vac
Trip classes (IEC 947-4-1)	5 - 10 - 15
Phase sequence protection	Yes
Phase imbalance protection	Over 40%. Tripping time < 3s
Undercurrent protection adjustable / Trip delay	From 0,5 to $0,9 \times I_B$. Operative from $0,3 \times I_B / 3s$
Reset mode for protection against dry running	I< manual, remote and automatic. More info in page 110
Reset mode for other protection functions	Manual, remote and automatic (every 15 minutes)
Short circuit withstand rating	5000 A at 0,5 s (SCR 5000@0,5 s)
Signalling LED's	4 LED's: ON + I> + I< + Phase sequence
Output contacts	1 relay with 1 NO + 1 NC
Switching power	I_B : 5A; AC15 - 250V - 2A; DC13 - 30V - 2A
Terminals: Max. section / screw torque	2,5 mm ² , No. 22 - 12AWG / 20Ncm, 1,8 LB - IN
Power consumption	2,5 VA
Protection degree / weight / mounting	IP20 / 0,5 kg / DIN rail
Storage temperature	-30°C +70°C
Operating temperature / max. altitude	-15°C +60°C / 1000m; -15°C +50°C / 3000m
Standards	IEC 255, IEC 947, IEC 801, EN 50081-2



THREE PHASE Pump Protection Relay without Level Sensors

THREE PHASE PUMP PROTECTION

Underload protection by $\cos \varphi$

- Eliminates need for level sensors to detect dry running.
- For 3-phase motors from 1 to 630 A and over. Cable feed through relay itself.
- Precise motor heating and cooling memory, reproduces its thermal image.
- Visual indication of tripping cause.
- Adjustable reset time for $\cos \varphi$.

Suitable for 3-phase submersible pumps, petrol station pumps, and other type of pumps and systems where running without load is critical (dry well, broken transmission belt, etc.).

The great advantage of these relays is that, by using the motor itself as a sensor and without requiring any external detectors, they monitor the $\cos \varphi$ of the motor and stop it before a breakdown caused by dry running, cavitation or closed valve occurs.

PF



PROTECTION FUNCTIONS

- $I >$ Overload
- $\cos \varphi$ Underload
- Δ Phase imbalance or phase loss
- (R) Phase sequence

WITHOUT LEVEL SENSORS

WITHOUT LEVEL SENSORS

MODELS		PF 16-R	PF 47-R
Adjustment range	I_B (A)	4 - 16,6	16 - 47,5
	CV	3 - 10	10 - 30
Motor 400 V	kW	2,2 - 7,5	7,5 - 22
	50/60 Hz		
Adjustment range	I_B (A)	4 - 16,6	16 - 47,5
	CV	1,5 - 5,5	5,5 - 15
Motor 230 V	kW	1,1 - 4	4 - 11
	50/60 Hz		
Code	according to the relay voltage supply	400/440 Vac 3-phase (motor)	12165
	(+15% -10%)	230 Vac 3-phase (motor)	12173
	ac: 50/60 Hz		12168
For I_N of the motor below the minimum setting I_B		Pass the cables several times (n) through the holes in the relay $I_B = n \times I_N$	
For I_N of the motor above the maximum setting I_B		Use 3 CT .../5 and the relay PF16-R	
External display module (optional)		ODPF	

CHARACTERISTICS	
Thermal memory / Overload trip	Yes / From 1,1 x I_B
Maximum motor nominal voltage	440 Vac
Trip classes (IEC 947-4-1)	10 - 20 - 30
Phase sequence protection	Yes
Phase imbalance protection	Over 40%. Tripping time < 3s
Underload protection by $\cos \varphi$ / Trip delay	$\cos \varphi$ adjustable from 0,15 to 1,0 / adjustable from 5 to 45s
Reset mode for protection against dry running	$\cos \varphi$ automatic (adjustable) and remote. More info in page 110
Reset mode for other protection functions	$I >$ Δ (R) Manual, remote and automatic. More info in page 110
Signalling LED's	4 LED's: ON + $I >$ + $\cos \varphi$ + Δ (R)
Output contacts	1 relay with 1 NO + 1 NC
Switching power	I_{th} : 5A; AC15 - 250V - 2A; DC13 - 30V - 2A
Terminals: Max. section / screw torque	2,5 mm ² , No. 22 - 12AWG / 20Ncm, 1,8 LB - IN
Power consumption	1,5W - 12 VA (230 Vac) - 20 VA (400 Vac)
Protection degree / weight / mounting	IP20 / 0,5 kg / DIN rail
Storage temperature	-30°C +70°C
Operating temperature / max. altitude	-15°C +60°C / 1000m; -15°C +50°C / 3000m
Standards	IEC 255, IEC 947, IEC 801, EN 50081-2

DIMENSIONS PS RELAY (mm)

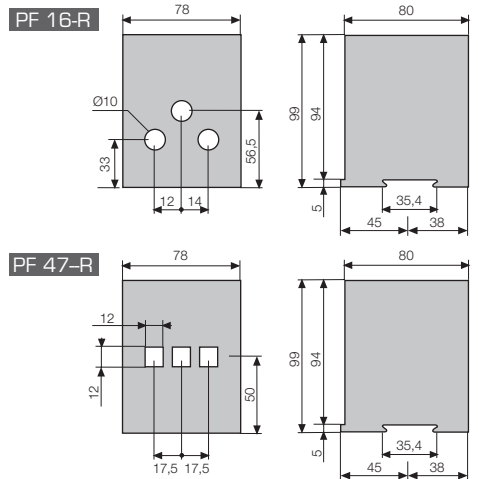

WIRING DIAGRAM

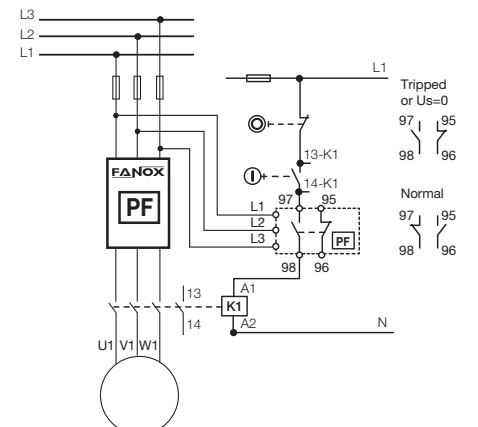

EXTERNAL DISPLAY MODULE

By means of this plug-in optional accessory, the relay status can be seen and reset from the exterior of the electrical panel board.

Easy to install. Size of a Ø22 mm push button.

Suitable for motor control centres (MCC) and panel boards.

This optional display module is mounted externally, e.g. on the panel door or a draw-out unit in a motor control centre (MCC) and connected to the relay by a flat cable (length 2 meters).

The module has the appropriate LED's to signal the trip cause and a reset push-button.

Weight: 0,05 kg.

Protection degree: IP50

"The PS and PF electronic relays have been specially designed to provide complete protection for both single and three phase pumps and any other system where dry running is a critical factor."

ODPF



Model	Code	Relay type
ODPF	12555	PF

DIMENSIONS ODPF MODULE (mm)

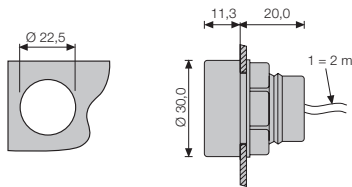

Fanox panel	Conventional panel
Electronic relay	Thermal relay Level electrode relay as well as Level electrodes Level electrode wiring

COST COMPARISON

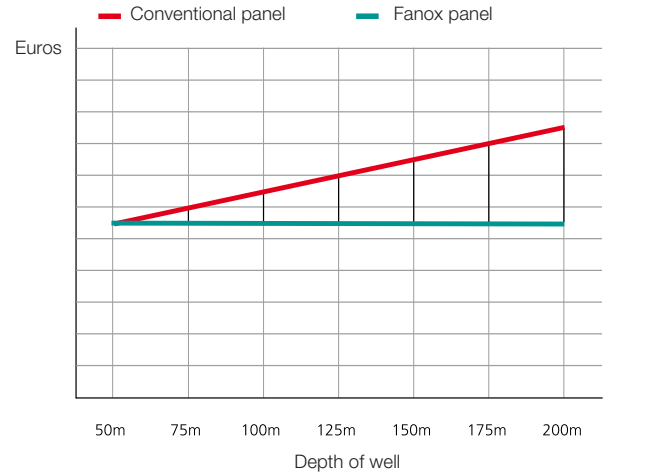

The graph shows that with FANOX SOLUTION you can save up to 35% of the cost of a pump protection system.

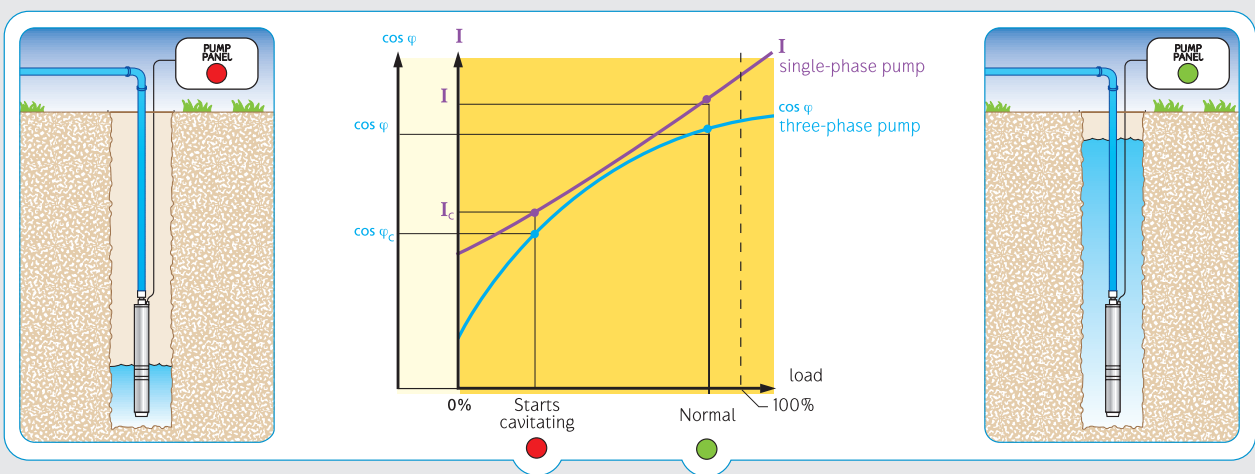

Installation and Adjustment guide

THE MOTOR PROTECTION

The electric motor is one of the most important operating devices in industry. Many times the shutdown of an industrial process is caused by a simple motor. High-cost production runs and valuable machinery can become paralysed at great cost, even more than the cost of rewinding the motor.

Experience shows that motor protection continues to be a problem, based on the number of breakdowns occurring every day.

Over 60% of failures are caused by overheating of the motor windings. These can be detected, and prevented, by measuring and analysing the current being absorbed by the motor, or by controlling temperature limits of the winding. The major causes are as follows:

- Overloads
- Locked rotor
- Over and undervoltage
- Phase imbalance or phase loss
- Long and heavy start-ups
- Excessive operating cycles
- Heating from non-electrical causes
- Inadequate motor ventilation
- High room temperature
- Insulation failure

The following diagram shows the dramatic decrease suffered in the electric life of a motor due to the excessive heat of the motor windings (Montsinger's rule).

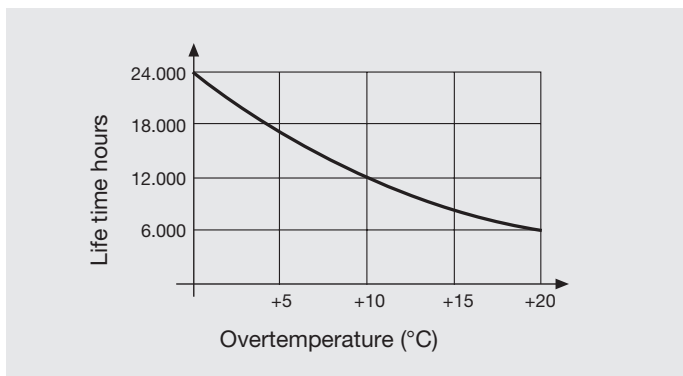

As one can see, a 10°C increase in temperature reduces the useful life of the motor by half.

The most reliable protection options in common use are:

- Fuses or circuit breakers for short-circuit protection.
- Electronic motor protection relays with thermal memory.
- Contactors for motor control.

FANOX RELAYS

Our R+D Division has allowed FANOX to develop a wide range of easy-to-install and operate electronic relays, at truly competitive prices, which will save downtime and money.

FANOX motor protection relays work with the current measured in real time. The current, which is read by three current transformers built into the relays, is electronically processed and used as a model of the thermal image of the motor, and is continuously compared to the values set on the relay.

The three power supply cables to the motor are not directly connected to the relay, but pass through its corresponding CT holes.

This provides motor protection against:

- **Overload:** The relay creates a model of the thermal image of the motor during its heating and cooling cycles. In this way, in overload conditions, the relay will take into consideration previous operating conditions of the motor, and will trip quicker if the relay has detected previous occasions of overload. This thermal memory is independent of the auxiliary voltage supply of the relay and is stored even when this voltage is cut off or disconnected. The different trip curves available for selection in the relays allow for precise adjustment to any kind of motor start-up or work ing cycle.
- **Phase imbalance and phase loss:** even if the motor is running below its full load current.
- **Incorrect phase sequence detection** is highly important when the correct phase sequence is critical as in compressors, pumps, fans and other applications (GL, P, PF).
- **Underload by undercurrent:** protects the motor against working without load, very important in pumps (P and PS).
- **Protection against no-load operation:** underload protection by $\cos \varphi$ has been incorporated so that the relay differentiates precisely between very low load and no-load operations, and drops out in the latter case (PF).

In addition, when the relay is connected to thermistor sensors (PTC), it protects the motor against electrical and non-electrical overheating (GL, G).

A visual display of the cause allows maintenance personnel to identify and immediately act on the underlying causes. The use of the OD display makes this operation much easier.

FANOX relays guarantee ideal protection for motors (pumps, compressors, fans, etc).

Installation and Adjustment guide

1 INSTALLATION

General

For correct installation and operation of Fanox relays, it is important to consider the following:

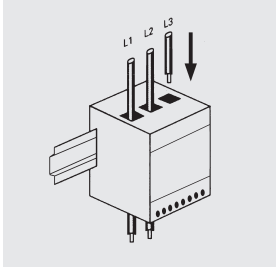

- After being fixed to the DIN rail, the cables for the three phases should be passed through the holes in the relay.

The maximum section of 700V insulated wires that can pass through the holes are:

C	16 mm ²
GL, P, PF, G, GEN	35 mm ²
GL 200	70 mm ²

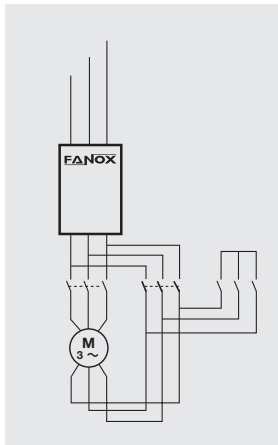

- Assembly attached to other components: it is recommended to separate the relays of other units or items that could cause strong magnetic fields, such as power or control transformers, contactors, frequency variators or high current busbars.

- In star-delta starting, the relay or the current transformers must be installed between the fuses or circuit breaker and the contactor.

- Relays used in combination with frequency inverters:

a) Not to be used with frequency inverters and fuel generators:

- GL relays if the protection against phase sequence selector is in the "ON" position.
- P and PF relays.

b) The following can be used with frequency inverters and fuel generators:

- GL relays if the protection against phase sequence selector is in the "OFF" position.
- C, G and PS16-R.

Never connect the relay or current transformers of the auxiliary power supply to the inverter output.

- Connection between the PTC sensors and the relay (GL and G). For PTC connection lengths over 100 m or when the influence of high frequency transient voltages is expected, it is advisable to use screened cable and connect the screen to terminal T1.

Note: every relay comes with an instruction manual providing information on its correct installation and setup. Please follow this for guidance.

2 SETUP PROCEDURE

Correct order of steps during installation:

	C	GL	G	PS	P	PF	GEN
2.1 Select the trip class / tripping time	1 st	1 st	1 st		1 st	1 st	1 st
2.2 Adjust the I_B current of the relay	2 nd	2 nd	2 nd	1 st	2 nd	2 nd	2 nd
2.3 Adjust the $\cos \varphi$ value (underload)						3 rd	
2.3 Adjust the $\cos \varphi$ trip delay						4 th	
2.4 Adjust the undercurrent level $I_{<}$ (underload)				2 nd	3 rd		
2.5 Select ON /OFF incorrect phase sequence		3 rd					
2.6 Reset	3 rd	4 th	3 rd	3 rd	4 th	5 th	3 rd

After installation and setup and before starting up the motor, make sure the motor is in a cold state. This will ensure that both the relay and motor, will operate with the same thermal memory (cold condition).

2.1 Trip class / tripping time (IEC 947-4-1). Relays C, GL, P, PF, G and GEN

The different trip classes / tripping times enable the user to select the overload protection according to the various motor applications in either short or long start-ups and for different generator uses.

The class number or the tripping time refers to the maximum approximate time in seconds allowed for the direct start of the motor from a cold condition.

To select the trip class or tripping time ($t_6 \times I_B$) use the corresponding dip switches. The recommended values are listed in the following tables.

Motor with direct start-up

Start time (s)	Trip classes												Trip time	
	Models													Model
	C9	C21	C45	GL16	GL40	GL90	GL200	P19	P44	P90	PF16-R	PF47-R		
1	10	10	10	10	10	10	10	5	5	5	10	10	4	
2	10	10	10	10	10	10	10	10	10	10	10	10	6	
3	10	20	20	15	15	15	15	10	10	10	20	20	10	
4	20	20	20	20	20	20	20	15	15	15	20	20	12	
5	20	30	30	20	20	25	25	15	15	15	20	20	16	
6	20	30	30	25	25	25	25				30	30	18	
7	30	30	30	30	30	30	30				30	30	22	
8	30	30	30	30	30	35	35				30	30	24	
9	30	30	30	35	35	35	35				30	30	28	
10	30	30	30	35	35	35	35				30	30	30	

Motor with star-delta start

Start time (s)	Trip classes												Trip time	
	Models													Model
	C9	C21	C45	GL16	GL40	GL90	GL200	P19	P44	P90	PF16-R	PF47-R		
5	10	10	10	10	10	10	10	5	5	5	10	10	4	
10	10	10	10	10	10	10	10	10	10	10	10	10	6	
15	20	20	20	10	15	15	15	10	10	10	10	20	8	
20	20	20	30	20	20	20	20	15	15	15	20	20	10	
25	30	30	30	20	20	25	25	15	15	15	20	20	14	
30	30	30	30	20	25	30	30				20	30	16	
35	30	30	30	20	30	35	35				20	30	18	
40	30	30	30	25	30	35	35				30	30	20	

Average trip curves (IEC 947-4-1)

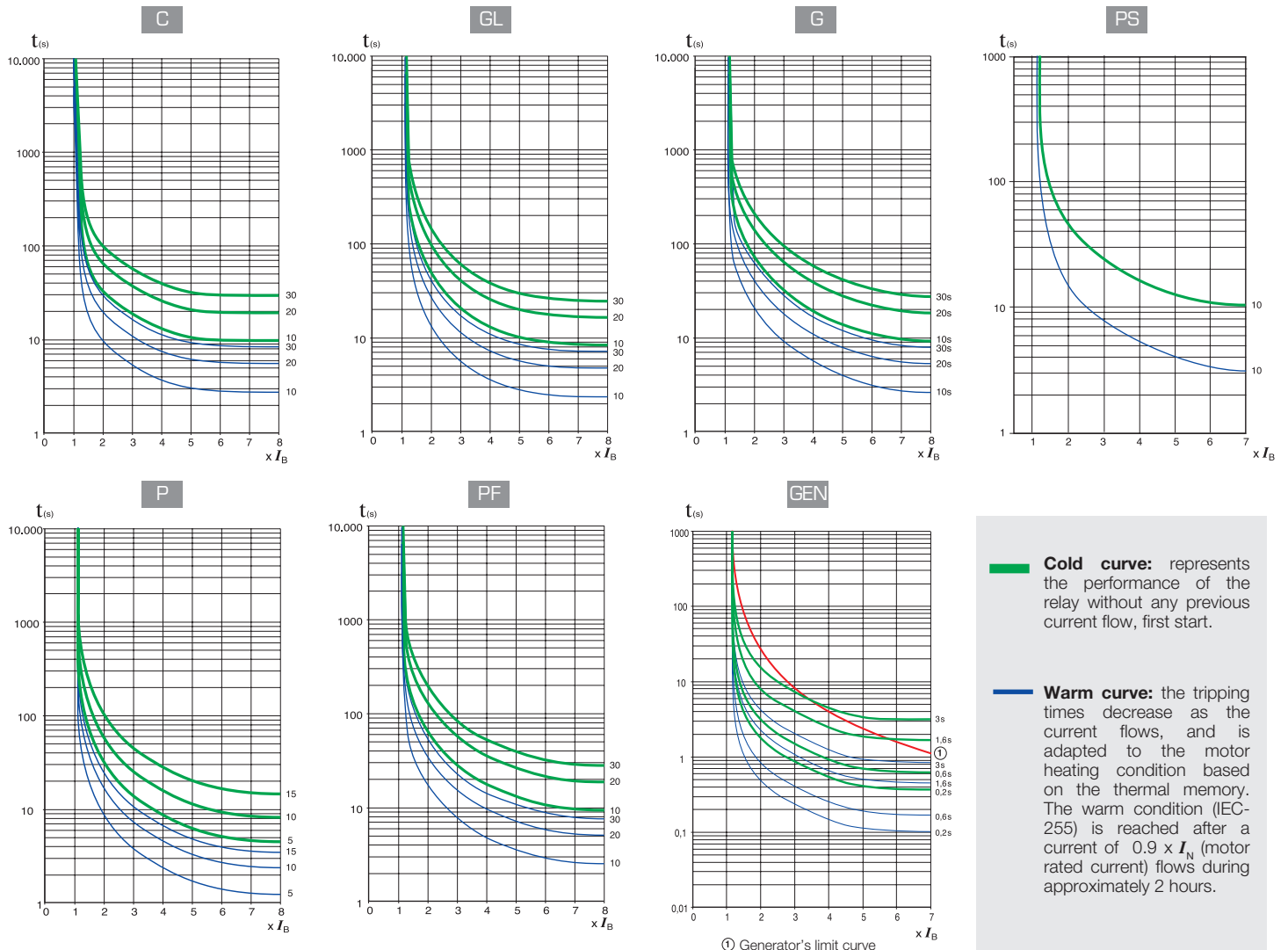

Cold curve: represents the performance of the relay without any previous current flow, first start.

Warm curve: the tripping times decrease as the current flows, and is adapted to the motor heating condition based on the thermal memory. The warm condition (IEC-255) is reached after a current of $0.9 \times I_N$ (motor rated current) flows during approximately 2 hours.

Installation and Adjustment guide

2.2 Current setting I_B .

Relays C, GL, P, PF, G, BG and GEN

Adjust the current I_B on the corresponding dipswitches (full load current). When setting the current take into account that the base current of the relay always remains added to the current selected with the dipswitches in "ON" position (to the right). The total addition is the set current I_B . Overload tripping current from $1,1 \times I_B$

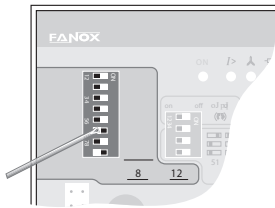

e.g.: relay GL16
 $I_B = 8 + 4 = 12 \text{ A}$

- a) For motor or generator rated currents (I_N) within the range of the relay, the setting I_B must be equal to the I_N of the motor or generator.

$$I_B = I_N$$

- b) For motor rated currents below the range of the relay, the setting I_B must be equal to the rated current of the motor I_N multiplied by the number of times that the conductors have been passed through the relay holes.

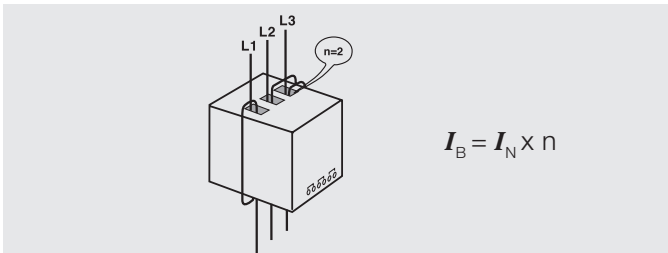

$$I_B = I_N \times n$$

- c) For motor or generator rated currents (I_N) above the range of the relay, use three current transformers .../5 in combination with the C9, GL16, P19, PF16-R, G17, BG17 or GEN10 according to application.

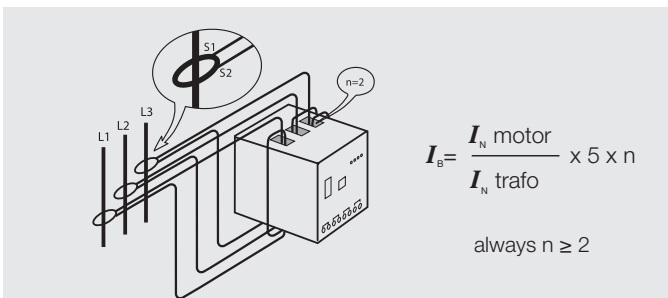

$$I_B = \frac{I_N \text{ motor}}{I_N \text{ trafo}} \times 5 \times n$$

always $n \geq 2$

With current transformers it is always a must to pass the conductors 2 times or more through the holes of the relay.

PS relay

This adjustment is to be made according to the nominal current of the motor I_N indicated in its characteristics plate. The value to be set I_B is the same as I_N . The relay trips with overloads above $1,1 \times I_B$.

$$I_B = I_N$$

2.3 Underload by $\cos \varphi$. PF.

The $\cos \varphi$ underload trip level is set by means of a potentiometer with settings from 0,15 to 1,0.

Select this value taking into consideration the no-load motor $\cos \varphi$ and that corresponding to the estimated minimum operating load. Choose an intermediate value between these two $\cos \varphi$ levels and set it in the relay.

Select the underload trip delay from 5 to 45 seconds using the 3 corresponding dipswitches (trip delay).

For your guidance you can find two practical examples below.

- a) A very oversized motor for its application. The $\cos \varphi$ of the motor is 0,15 when working without load.

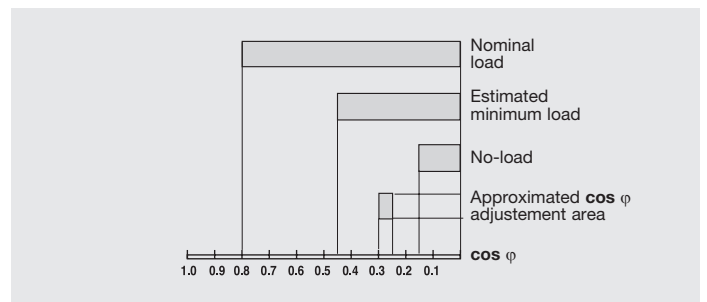

- b) A slightly oversized motor for its application. The $\cos \varphi$ of the motor is 0,25 when working without load.

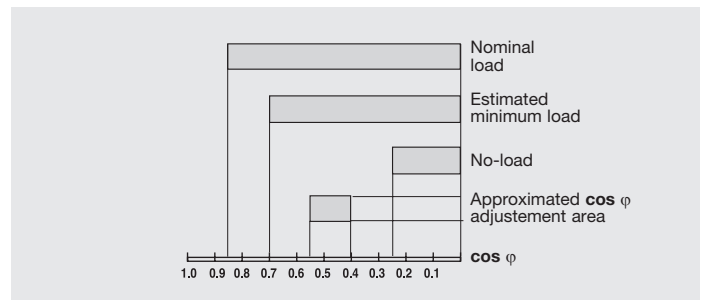

If the above mentioned $\cos \varphi$ values are unknown, the underload trip setting can be made in the following way:

1. Set the underload trip delay to zero by moving the three dipswitches to the left (trip delay).
2. Using the potentiometer ($\cos \varphi$ setting), set the $\cos \varphi$ value to the minimum: 0,15.
3. Set the reset time to the minimum value using the potentiometer ($\cos \varphi$ reset time).
4. Start up the motor and run it with the minimum estimated load.
5. Slowly turn the $\cos \varphi$ potentiometer clockwise until the relay trips and the $\cos \varphi$ LED lights up.
6. Turn the $\cos \varphi$ potentiometer anticlockwise until the $\cos \varphi$ is set at approximately 30% less than the previous value (point 5).
7. Set the underload trip delay using the 3 corresponding dip switches. Set the reset time using the adequate potentiometer.

2.4 Undercurrent.

Single phase relay PS

The setting of the underload trip level is made using a potentiometer in which a factor between 0,4 and 0,9 is to be chosen. By multiplying this factor by the adjusted I_b we obtain a current value under which the relay will trip and disconnect the motor. The trip is delayed by 5 seconds.

a) If the value of the I_b of the motor without load is known:

- To avoid unwanted trips it is recommended to adjust the value 15% above the I_b of the motor without load.

Example:

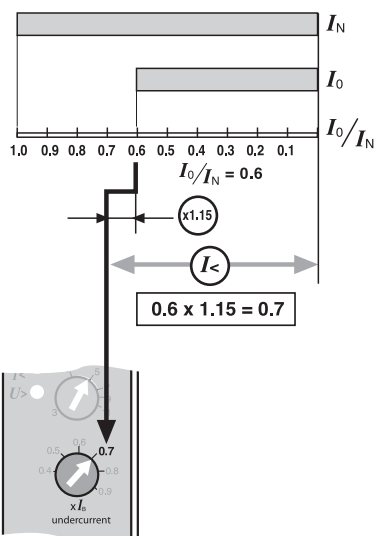
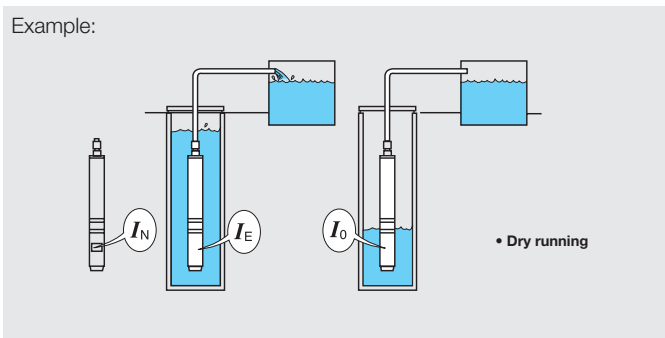

b) If the value of the I_b of the motor without load is unknown:

- If the pump is adequately dimensioned, the recommended value for this factor is 0,7. Adjust the potentiometer "undercurrent" to 0,7.
- If the pump is excessively dimensioned, and during its operation unwanted trips could occur, the underload adjusted factor should be reduced to approximately 0,6.

Three phase relay P

The undercurrent trip level in P relays is set using three dipswitches. To avoid nuisance trips, set this level to approximately 10% above the no-load motor current.

Example:

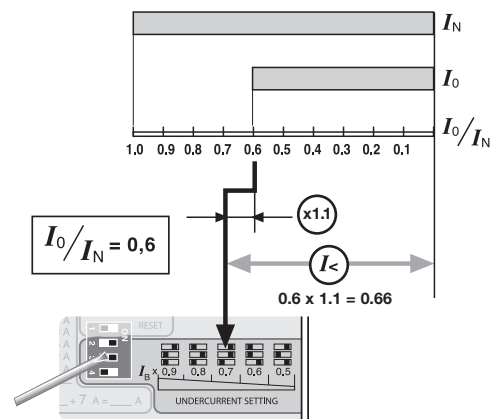
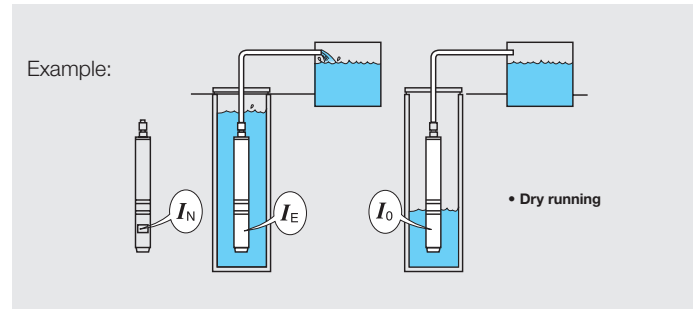

2.5 Phase sequence

Monitoring the current. GL and P relays

An incorrect phase sequence is detected by current sensing and it is only operative during the motor start-up. For correct detection the starting time must be longer than 0.2 s.

In GL relays the user can activate or deactivate this protection by means of a dipswitch. Should the right phase sequence be critical, move the dipswitch to the "ON" position. If this protection is not required, always leave it in the "OFF" position.

As this function is not compatible with the use of frequency inverters, where it is necessary to protect phase sequence in these installations, move the dipswitch to "OFF" and install the Fanox "S" model relay.



Monitoring the voltage. PF relays

An incorrect phase sequence is detected by voltage monitoring.



In the event that an incorrect phase sequence has been detected, the motor will not start-up since the relay has tripped because of previously detecting the wrong phase sequence.

Installation and Adjustment guide

2.6 Reset



Relays	manual	remote	autom.
C, GL, G, GEN	•	•	
P, PF	man 	man 	auto 
PS		•	•

Manual reset:

	PS	P	PF	C	GL	G	GEN
$I >$	NO	<5 m	<7 m	<8 m	<8 m	<8 m	<1 m
$I <$	NO	2 s	-	-	-	-	-
cos φ	-	-	NO	-	-	-	-
	-	2 s	2 s (*)	2 s	2 s	2 s	2 s
	-	2 s	2 s (*)	2 s	2 s	-	-
$U >$	NO	-	-	-	-	-	-
	-	-	-	-	1 s (*)	1 s (*)	-



(*) After recovering normal conditions.

Remote reset:

	PS	P	PF	C	GL	G	GEN
$I >$	<1 m	<1 m	<3 m	<3 m	<3 m	<3 m	<1 m
$I <$	10 s	10 s	-	-	-	-	-
cos φ	-	-	10 s	-	-	-	-
	-	10 s	10 s	20 s	20 s	10 s	10 s
	-	10 s	10 s	10 s	10 s	-	-
$U >$	NO	-	-	-	-	-	-
	-	-	-	-	1 s (*)	1 s (*)	-

It is necessary to disconnect the auxiliary voltage more than 3 seconds after having waited the time indicated in the table.

Automatic reset:

	PS	P	PF	C	GL	G	GEN
$I >$	4 m	15 m	4 m	NO	NO	NO	NO
$I <$	PS11-R	2-70 m	15 m	-	-	-	-
	PS16-R	2-240 m					
cos φ	-	-	2-75m	-	-	-	-
	-	15 m	4 m (*)	NO	NO	NO	NO
	-	15 m	4 m (*)	-	NO	-	-
$U >$	1 s (*)	-	-	-	-	-	-
	-	-	-	-	NO	NO	-

(*) After recovering normal conditions.

3 OPERATING TEST. C, GL, P, PF, G and GEN

To perform the trip test for phase loss, the current which passes through the relay must be higher than 0.7 of the set current I_s . Under these conditions, push and hold the TEST button for three seconds, the relay will trip due to phase loss and the corresponding LED will light up.

4 APPLICATIONS

Industries

- OEM (Original Equipment Manufacturers)
- Chemical and petrochemical
- Quarries, gravel pits and cement factories
- Steelworks, iron and steel industry
- Automotive
- Utilities and electric generation
- Water treatment and distribution
- Mining
- Food industry, sugar industry
- Marine and shipbuilding
- Timber industry
- Elevation industry
- HVAC (Heat Ventilation Air Condition)

Installations

- Motor Control Centers (MCC)
- EEx e motors in explosive environments
- Submersible pumps, in service stations and water pumping, surface pumps, etc
- Compressors
- Fans, blowers and ventilators
- Industrial refrigeration and air conditioning
- Centrifuges
- Presses
- Cranes, elevators, escalators and lifting machinery
- Machine tool
- Conveyor belts
- Mills and mixers
- Generators and alternators.

5 NOMINAL CURRENT RATING OF ASYNCHRONOUS THREE-PHASE MOTORS

The current values listed in the following table correspond to the average ratings given by various manufacturers. In some cases, these may not coincide exactly with the ratings listed on the motor data plates.

kW		0,75	1,1	1,5	2,2	3	3,7	4	5,5	7,5	11	15	18,5	22	30	37	45	55	75	90	110	
CV		1	1,5	2	3	4	5	5,5	7,5	10	15	20	25	30	40	50	60	75	100	125	150	
Average values	MOTOR 4P	230 V 50Hz	3,5	5	6,5	9,5	11	-	15	22	28	42	54	68	80	104	130	154	192	248	312	360
		400 V 50Hz	2	2,5	3,5	5	6,5	-	8,5	11	15	22	29	35	42	57	69	81	100	131	162	195
		440 V 50Hz	1,7	2,4	3,2	4,5	6	-	8	10,5	14	20	27	33	39	52	64	76	91	120	147	178
		220/240 V 60Hz	3,2	4,4	6,2	8,5	10,5	-	14	20	26	38	50	63	74	98	122	146	180	233	290	345
		440/460 V 60Hz	1,5	2,2	3	4,3	5,5	-	7,5	10	13	19	25	31	37	49	61	73	90	116	144	173
		400 V 50Hz	2,0	2,8	3,8	5,5	7	-	9,5	13	16,5	24	32	40	47	64	79	92	113	149	183	220
	MOTOR 2P	440/460 V 60Hz	1,9	2,5	3,4	4,8	6	7,5	-	11	15	21	27	33	39	53	65	79	95	120	153	183

CONTROL & MEASUREMENT

Introduction





Fanox' range of Control and Measurement relays come with many functions:

- **Phase and temperature control relays** for elevators with and without machine room. These indicate cause of failure, are self-powered and have a compact size of 22.5 mm (standard industrial size) which facilitates the installation of the product assembly.
- **Voltage relays** with direct adjustment potentiometer, which eliminates the calculation of percentage facilitating installation and commissioning.
- **Timers** multifunction microprocessor with built-in battery that allows programming without connecting auxiliary voltage.



Selection guide

CONTROL RELAYS

MODELS	NOMINAL VOLTAGE	RANGE						$U >$	$U <$	I_N	$\frac{Hz >}{Hz <}$
S2	3 x 230 Vac		•	•							
S4	3 x 400 Vac		•	•							
ST2	3 x 230 Vac		•	•	•		•				
ST4	3 x 400 Vac		•	•	•		•				
ST2-D	3 x 230 Vac		•	•	•		•				
ST4-D	3 x 400 Vac		•	•	•		•				
T2	230 Vca	-5° C / +5° C -40° C / +55° C				•					
T2	24 Vac-dc	-5° C / +5° C -40° C / +55° C				•					
TST-24	24 Vac-dc	-5° C / +5° C -40° C / +55° C	•	•	•	•	•				
MT2	230 Vac					•	•				
U1D-24D	24 Vdc	19 - 28						•	•		
U1D-115	115 Vac	90 - 135						•	•		
U1D-230	230 Vac	160 - 275						•	•		
U3S-230	230 Vac	185 - 290	•	•				•	•		
U3S-420	420 Vac	350 - 500	•	•				•	•		
U3N-230	230 Vac	200 - 260	•	•				•	•	•	
U3N-400	400 Vac	340 - 460	•	•				•	•	•	
U3N-440	440 Vac	380 - 500	•	•				•	•	•	

$I >$
Overload

$I <$
Undercurrent

$\cos \varphi$
Underload

Phase loss
Phase imbalance

Phase sequence

Overtemperature

$\frac{U >}{U <}$
Overvoltage /
Undervoltage

I_N
Loss of neutral

$\frac{Hz >}{Hz <}$
Overfrequency /
Underfrequency

Max / Min
temperature

Thermistor
short-circuit

PHASE Control Relays

PHASE CONTROL

- Self-powered by the voltage to be monitored.
- Visual indication of trip cause.
- DIN rail mounting.
- To protect 3-phase devices and during operation of Lifts & Elevators.
- Suitable for air conditioning, cranes, hoists and similar installations for protection during startup.
- Sensitive to incorrect phase sequence.

S



CE

PROTECTION FUNCTIONS

- ⚡ Phase imbalance or phase loss
- (R) Phase sequence

MODELS	S2	S4
Nominal voltage of the line to be monitored ($\pm 15\%$)	3 x 230 V	3 x 400 V
Voltage supply ($\pm 15\%$)	Self-powered (3-phase)	
Code	12033	12034

DIMENSIONS S RELAY (mm)

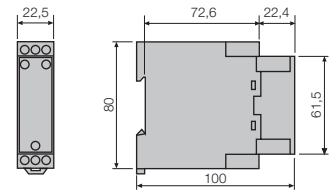

CHARACTERISTICS	
Nominal frequency	50/60 Hz
Control range	Phase loss: with resistive loads it trips when a phase loss occurs. With three-phase motors it trips if the voltage regenerated by the motor is lower than 60% of the main voltage. Phase imbalance > 40%
Trip time delay	< 0,1 s
Reset mode	Automatic
Signalling LED's	2 LED's: ON + ⚡ (R)
Output contacts	1 relay with 1 change over NO - NC
Switching power	I_n : 5A; AC15 - 250V - 2A; DC13 - 30V - 2A
Maximum terminal section / screw torque	2,5 mm ² , No. 22 - 12AWG / 20Ncm, 1.8 LB - IN
Power consumption	7,5 VA (230 Vac) - 11 VA (400 Vac)
Protection degree / weight	IP20 / 0,12 kg
Storage / operation temperature	-30°C +70°C / -15°C +60°C

WIRING DIAGRAM

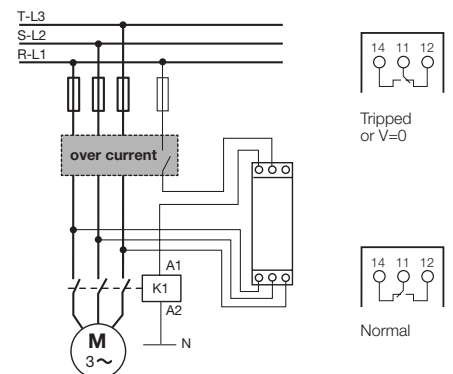

WORK LOGIC

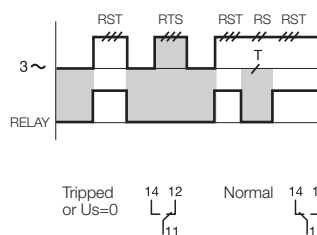

PHASE and TEMPERATURE Relays

PHASE AND TEMPERATURE CONTROL

- Self-powered by the voltage to be monitored.
- Visual indication of trip cause.
- DIN rail mounting.
- To protect 3-phase devices and during operation of Lifts & Elevators.
- Suitable for motors with built-in PTC sensors in applications such as elevators, cranes, hoists and similar installations.
- Sensitive to incorrect phase sequence.
- Monitoring of short circuit and ruptured wire in PTC circuit.

ST-D model:

Two output relays, one for phase imbalance, phase loss and phase sequence and the other for over temperature.

ST



PROTECTION FUNCTIONS

- Phase imbalance or phase loss
- Phase sequence
- Overtemperature
- Thermistor short-circuit

ST-D



CE

MODELS	ST2	ST4	ST2-D	ST4-D
Nominal voltage of the line to be monitored ($\pm 15\%$)	3 x 230 V	3 x 400 V	3 x 230 V	3 x 400 V
Voltage supply ($\pm 15\%$)	Self-powered (3-phase)			
Code	12001	12012	12002	12013

CHARACTERISTICS	
Nominal frequency	50/60 Hz
Control range	Phase loss: with resistive loads it trips when a phase loss occurs. With three-phase motors it trips if the voltage regenerated by the motor is lower than 60% of the main voltage. Phase imbalance > 40%
PTC sensor: min/max cold resist - Trip resist	100Ω / 1500Ω - 2300Ω
Trip time delay	< 0,1 s
Reset mode	Automatic
Signalling LED's	3 LED's: ON + Δ (F) + ---
Output contacts	1 relay with 1 change over NO - NC 2 relays (Δ (F) + ---) with 1 NO
Switching power	I_{in} : 5A; AC15 - 250V - 2A; DC13 - 30V - 2A
Maximum terminal section / screw torque	2,5 mm ² , No. 22 - 12AWG / 20Ncm, 1,8 LB - IN
Power consumption	7,5 VA (230 Vac) - 11 VA (400 Vac)
Protection degree / weight	IP20 / 0,12 kg IP20 / 0,13 kg
Storage / operation temperature	-30°C +70°C / -15°C +60°C

DIMENSIONS ST RELAY (mm)

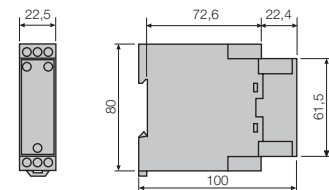

WIRING DIAGRAM

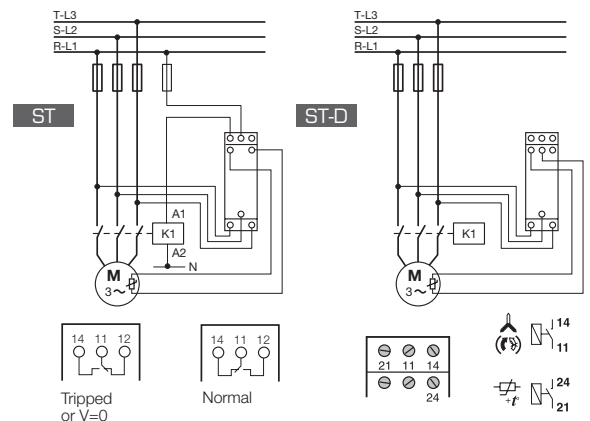

WORK LOGIC

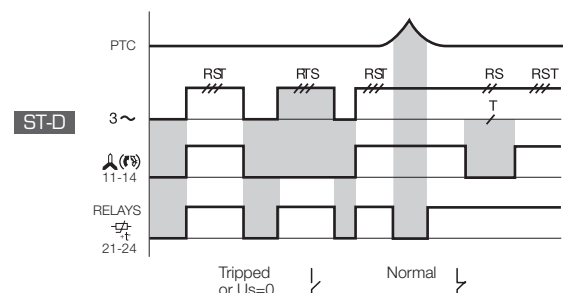
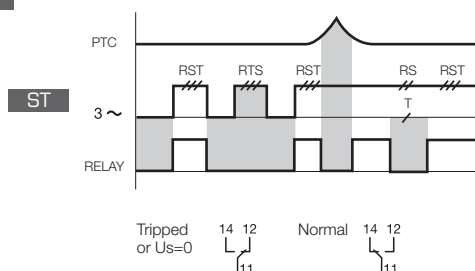

T2 - TST24

PHASE and TEMPERATURE Control Relays (Lifts)

- Protection relay against variations of the ambient temperature (min/max), overtemperature of the motor, phase sequence and phase imbalance or phase loss.
- DIN rail mounting.
- Visual indication of trip cause.

TEMPERATURE CONTROL

- Controls the temperature of the motor room (relay + external module OD-T2) or the temperature inside switchboards where no motor room is present. (relay + internal sensor IN-T2).
- Designed according to the EN 81-1 standard and complying with the European Union Directive for Lifts (95/16/CE).
- Two adjustable temperature thresholds.

PHASE AND TEMPERATURE (PTC) RELAY

- To Protect 3-phase devices.
- Suitable for Motors with built-in PTC sensors in applications such as elevators, cranes, hoists and similar installations.
- Sensitive to incorrect phase sequence.
- Monitoring of short circuit and ruptured wire in PTC circuit.

T2



ODT

External module

PROTECTION FUNCTIONS T2

Temperature variation

CE

TST24



INT2

Internal sensor

PROTECTION FUNCTIONS TST24

Phase imbalance or phase loss

Phase sequence

Overtemperature

Temperature variation

Thermistor short-circuit

MODELS	T2		TST24	ODT2	INT2
Nominal voltage of the line to be monitored ($\pm 15\%$)	-		3 x 400 V	-	-
Voltage supply ($\pm 15\%$)	230 Vac (Aux)	24 Vac, dc (Aux)	24 Vac, dc (Aux)	-	-
Code	12051	12052	12090	12037	12036

CHARACTERISTICS	
Nominal frequency	50/60 Hz
Control range	Maximum temperature from 40°C to 55°C. Phase loss: with resistive loads relay trips when a phase loss occurs. With three-phase motors relay trips if the voltage regenerated by the motor is lower than 60% of the main voltage. Phase imbalance > 40%. Minimum temperature from -5°C to 5°C. Minimum temperature setting from -5°C a 5°C.
Hysteresis	2°C
PTC sensor: min/max cold resist - Trip resist	100 Ω / 1500 Ω - 2300 Ω
Trip time delay	< 0,1 s
Reset mode	Automatic
Signalling LED's	2 LED's: ON + 3 LED's: ON + +
Output contacts	1 relay with 1 change over NO - NC 1 relay NO-NC () - 1 relay NO-NC ()
Switching power	T2: I _n : 5A; AC15 - 250V - 2A; DC13 - 30V - 2A TST24: I _n : 5A; AC15 - 250V - 2A; DC13 - 30V - 2A; DC13 - 115V - 0,2A
Maximum terminal section / screw torque	2,5 mm ² , No. 22 - 12AWG / 20Ncm, 1.8 LB - IN
Power consumption	7,5 VA (230 Vac) - 11 VA (400 Vac)
Protection degree / weight	IP20 / 0,12 kg IP20 / 0,13 kg
Storage / operation temperature	-30°C +70°C / -15°C +60°C

DIMENSIONS (mm)

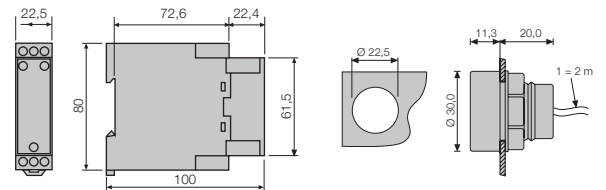

WIRING DIAGRAM

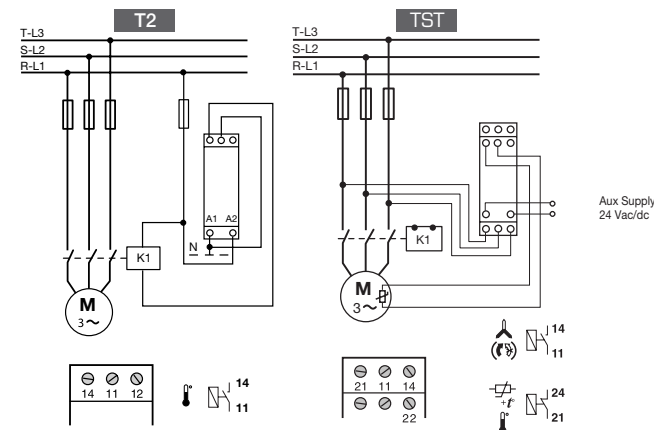

WORK LOGIC

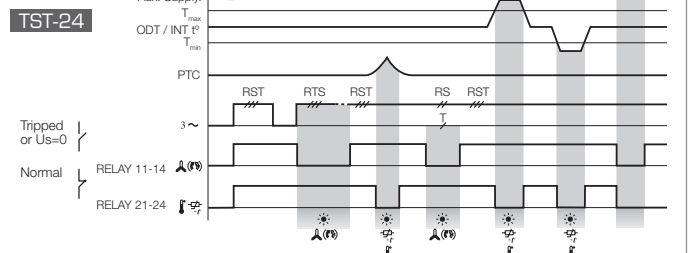
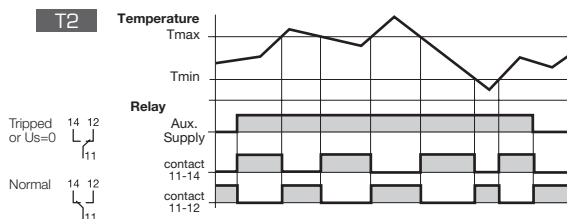

TEMPERATURE Control Relay by Thermistors

TEMPERATURE CONTROL BY THERMISTORS

- Protection of the motor against overtemperature.
- DIN rail mounting.
- Visual indication of trip cause.
- Controls the temperature by the use of thermistors (PTC sensors).
- Detects short-circuit (< 25Ω) and rupture in the circuit of sensors.
- Protects the motors against over temperature caused by excessive ambient temperature, insufficient ventilation or cooling, etc.
- Applicable in transformers and other machines.

MT2



PROTECTION FUNCTIONS

- Overtemperature
- Thermistor short-circuit

CE

MODELS	MT2
Voltage supply (±15%)	230 Vac (Aux. supply)
Code	12039

DIMENSIONS (mm)

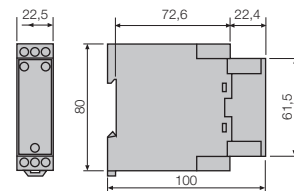

CHARACTERISTICS	
Nominal frequency	50/60 Hz
Control range	According to the PTC installed
PTC sensor: min/max cold resist - Trip resist	25Ω / 1500Ω - 3600Ω. Reset 1800Ω
Trip time delay	< 0,1 s
Reset mode	Automatic (30s delay)
Signalling LED's	3 LED's: ON + +
Output contacts	1 relay with NO-NC
Switching power	I _m : 5A; AC15 - 250V - 2A; DC13 - 30V - 2A
Maximum terminal section / screw torque	2,5 mm ² , No. 22 - 12AWG / 20Ncm, 1,8 LB - IN
Power consumption	6 VA (230 Vac)
Protection degree / weight	IP20 / 0,12 kg
Storage / operation temperature	-30°C +70°C / -15°C +60°C

WIRING DIAGRAM

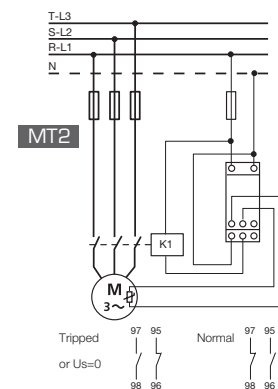

WORK LOGIC

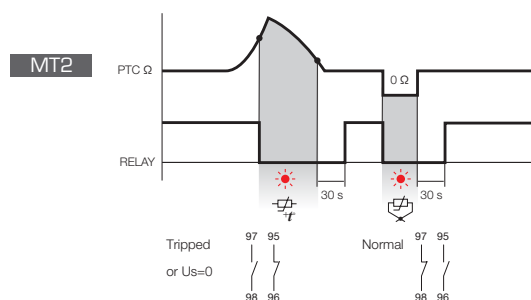

U1 D

VOLTAGE Control Relays

SINGLE - PHASE VOLTAGE RELAY

- *Self-powered by the voltage to be monitored.*
- *Visual indication of trip cause.*
- *DIN rail mounting.*
- Minimum and maximum thresholds adjustable (two potentiometers).
- Adjustable trip time delay. Instantaneous reset. Protects equipment such as digital instruments or electrical equipment from voltage variations in the network.

U1 D



PROTECTION FUNCTIONS

- $U>$ Overvoltage
- $U<$ Undervoltage

MODELS	U1D-24D	U1D-115	U1D-230
Frequency	DC	50/60 Hz	50/60 Hz
Maximum threshold V	23-28	105-135	215-275
Minimum threshold V	19-25	90-120	160-230
Code	12028	12026	12027

CHARACTERISTICS	
Type of supply to be monitored	Single phase
Auxiliary supply $\pm 10\%$	Self-powered
Accuracy	$U>$ +4% -1%; $U<$ +1% -4%
Trip time delay (TD)	0,1 to 6s ($\pm 20\%$) for $U>$ $U<$
Reset time delay (RD)	No
Reset mode	Automatic
Hysteresis	4% of the nominal voltage
Signalling LED's	3 LED's: ON + $U>$ + $U<$
Output contacts	1 relay with 1 change-over NO - NC
Switching power	I_n : 5A; AC15 - 250V - 2A; DC13 - 30V - 2A
Terminals: Max. section / Screw torque	2,5 mm ² , No. 22 - 12AWG / 20Ncm, 1,8 LB - IN
Power consumption	3 VA (115 Vac) - 7 VA (230 Vac) - 0,7W (24 Vdc)
Protection degree / weight	IP20 / 0,11 kg
Storage / operation temperature	-30°C +70 °C / -15°C +60°C

DIMENSIONS U1D RELAY (mm)

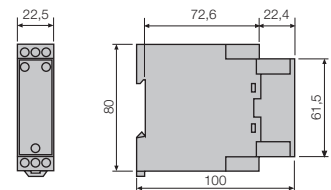

WIRING DIAGRAM

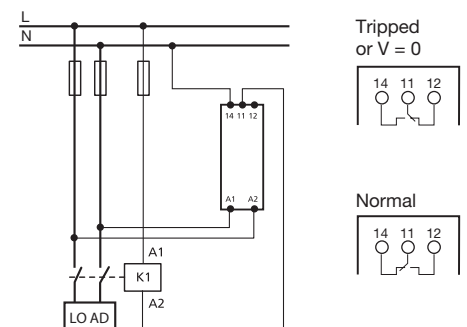

WORK LOGIC

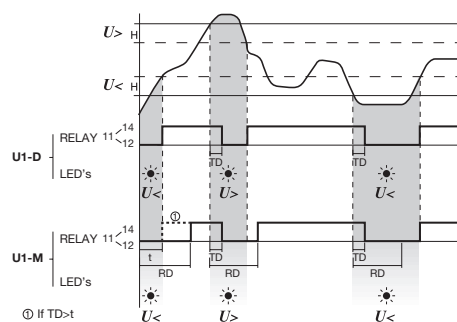

VOLTAGE Control Relays

THREE - PHASE VOLTAGE RELAY

- Self-powered by the voltage to be monitored.
- Visual indication of trip cause.
- DIN rail mounting.

- Protects three-phase installations against voltage variations between phases, incorrect sequence of phases and phase loss.
- Adjustable minimum and maximum thresholds.
- Adjustable trip time delay.

U3S model:

- Model U3S-420 is valid for 400 and 440 nominal voltage.

U3N models:

- Two independent output relays.
- Includes protection against neutral loss.

U3 S



U3 N

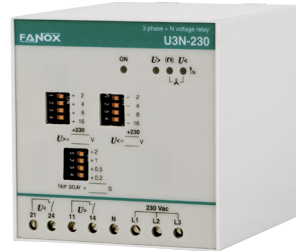

PROTECTION FUNCTIONS

- $U >$ Overvoltage
- $U <$ Undervoltage
- Phase imbalance or phase loss
- Phase sequence

Model U3 N includes:

- Loss of neutral

MODELS	U3S-230	U3S-420	U3N-230	U3N-400	U3N-440
Frequency	50/60 Hz	50/60 Hz	50/60 Hz	50/60 Hz	50/60 Hz
Maximum threshold V	210-290	380-500	230-260	400-460	440-500
Minimum threshold V	185-230	350-430	200-230	340-400	380-440
Code	12071	12070	12056	12055	12057

CHARACTERISTICS	
Type of supply to be monitored	Three phase / Three-phase with neutral
Auxiliary supply $\pm 10\%$	Self-powered
Accuracy	$U >$ +4% -1%; $U <$ +1% -4%
Trip time delay (TD)	0,1 to 6s ($\pm 20\%$) for $U >$ $U <$ / 0,1 to 3,7s ($\pm 20\%$) for $U >$ $U <$ *
Reset mode	Automatic
Hysteresis	4% of the nominal voltage
Signalling LED's	U3S: 4 LED's: ON + $U >$ + (P) Δ + $U <$ Δ / U3N: 4 LED's: ON + $U >$ + (P) Δ + $U <$ Δ *
Output contacts	U3S: 1 relay with 1 change-over NO - NC / U3N: 2 relays with 1 NO
Switching power	I_{th} : 5A; AC15 - 250V - 2A; DC13 - 30V - 2A
Terminals: Max. section / Screw torque	2,5 mm ² , No. 22 - 12AWG / 20Ncm, 1,8 LB - IN
Power consumption	U3S: 7,5 VA (230 Vac) - 11 VA (400 Vac) / U3N: 12 VA (230 Vac) - 20 VA (400 Vac)
Protection degree / weight	IP20 / 0,11 kg / IP20 / 0,35 kg
Storage / operation temperature	-30°C +70 °C / -15°C +60°C

DIMENSIONS RELAYS (mm)

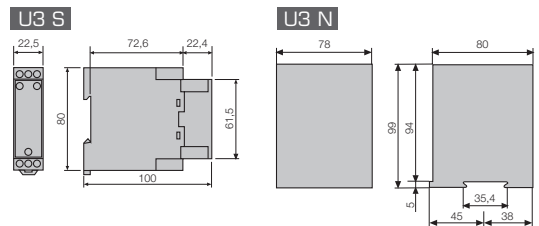

WIRING DIAGRAM

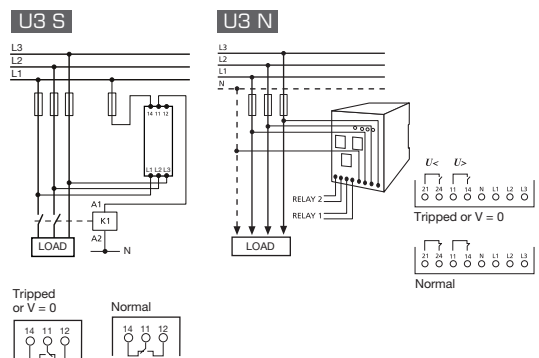

WORK LOGIC

U3S

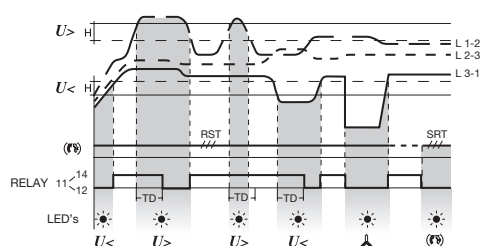

U3N

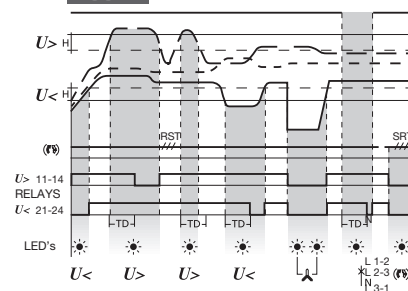

MTR 10

Timers

- **Multifunction digital timer.**
- **Possibility of programming up to 9 different times. Each time can be set from 0,1 seconds to 99 hours.**
- **With built-in battery which allows timer to be programmed without connecting to auxiliary voltage. Complete battery discharge does not affect operation or adjustment settings.**
- For control and automation systems in industry.
- Command contact with 5 programmable functions.
- 2 digit, 7 segment LED displays and push-buttons provide programming, and during operation allow for monitoring of the time period and reviewing the programmed settings.
- 45 mm module size, 35 mm wide. DIN EN 50022-35 rail mounting.

MTR 10



Programmable parameters

- Initial state of output relays: energized (1H) or de-energized (1L).
- Working mode: cycle (C1) or non-cycle (C0).
- Number of different times per program: up to 8 in cycle mode and up to 9 in non-cycle mode.
- Time setting range: from 0,1 seconds to 99 hours.
- Command contact.

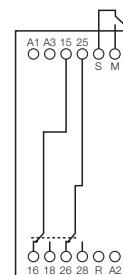

Auxiliary voltage
A1-A2: 230 Vac
A2-A3: 24 Vac, dc

MODEL	MTR 10	
Auxiliary power supply (+15 -10%)	230 V 50/60 Hz, 24 Vdc, ac	48 Vdc
Code	12110	12111

CHARACTERISTICS	
Time setting range	From 0,1 seconds to 99 hours
Accuracy	1% ±10 ms
Repeat accuracy	0,5%
Number of different times per program	Up to 8 in cycle mode and 9 in no-cycle
Output contacts	1 relay with 2 timed change over contacts NO-NC
Switching power	I_{th} : 5A; AC15 - 250V - 2A; DC13 - 30V - 2A
Terminals: max section / screw torque	2,5 mm ² , No. 22 - 12AWG / 20Nm, 1,8 LB - IN
Mechanical / electrical life	>20 x 10 ⁶ operations / >10 ⁵ operations
Consumption	8 VA (230 Vca) - 1W (24 Vdc) 2,5 VA (48 Vdc) - 1W (24 Vdc)
Protection degree / weight	IP 40 front / 0,15 kg
Storage / operation temperature	-30°C +70°C / -20°C +55°C
Standards	IEC 255

Command contact

- Can be switched on in two ways:
- By closing an external voltage free contact between M and S
- By connecting 5-35 Vac,dc between M(+) and R(-)

One of the following arrangements can be programmed:

Each diagram represents the effect of the command contact for the two initial states of the output relay: de-energized (1L) and energized (1H).

cu Switched off contact

Its function is blocked

cr Reset contact

When connected the output relay is de-energized; upon disconnecting, the programmed timing starts.

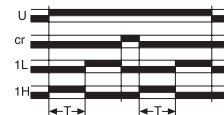

cl Pause contact

A pause in the timing takes place during its operation.

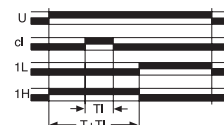

ci Delay on contact

When disconnected the output relay is de-energized; when connected the programmed timing starts.



co Delay off contact

When disconnected the output relay is de-energized. When connected, the relay is energized. When disconnected again, the programmed timing starts.

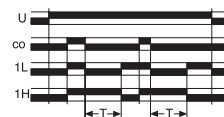

FUNCTION EXAMPLE DIAGRAMS

U: power supply **R:** relay output
Output relay at start: **1L** de-energized; **1H** energized.
Work mode: **CO** non-cycle; **C1** cycle.
Command contact: **cu**, **cr**, **cl**, **ci**, **co**.

Delay on
1L - CO - cu



Timing on
1H - CO - cu



Delay off
With command contact
1H - CO - co



Double timing

1L - CO - cu

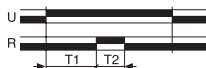

Double timing

Cycle work mode
1H - C1 - cu

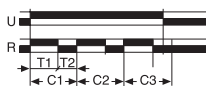

Four timings

Cycle work mode
1H - C1 - cu



Timing with pause
by command contact
1L - CO - cl



DIMENSIONS MTR 10 RELAY (mm)

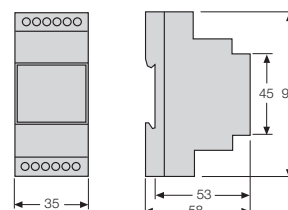

Thermistor Sensors

THERMISTOR SENSORS PTC

- Connected to PBM B, GL, G, ST or MT relays to protect motors against overtemperature.
- PTC. Positive Temperature Coefficient
- PTC 120, and PTC 160 for internal mounting. Temperature threshold 120°C and PTC 160°C.
- PTCEX 70, for external mounting. Temperature threshold 70°C.

PTC



PTCEX 70

CE

Models	PTC 120		PTC 160	PTCEX 70	
Code	41700/41701		41702	41705	
Threshold temperature	120°C		160°C	70°C	
Threshold resistance	≥ 1330 Ω		≥ 1330 Ω	≥ 1330 Ω	
Mounting	internal		internal	external	
Length in-built (m)	0,5	0,2	0,5	-	
Length of wire accessory (m)	-		-	0,5 (17008)	1 (17009)



PTC 120 /160

DIMENSIONS PTC (mm)

Ø 3 mm



PTC 120

PTC 160

Ø 3,7 mm

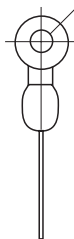

PTCEX 70

EARTH LEAKAGE PROTECTION

Introduction

The safety of people and human capital is always important. Fanox Earth Leakage Relays are the most effective devices to ensure protection against the dreaded risk of electrical leakage at low voltage.

Our relays feature characteristics that are ideal for preventing hazardous situations, such as:

- **Super Immune:** Our relays are specially designed to work in environments with extreme electrical noise, providing signal immunity to interferences such as frequency. This helps avoiding false alarms and unnecessary stops.
- **Enhanced security:** The enhanced security feature is a backup metering channel. An alarm is triggered to inform of the need for maintenance at the next halt.
- **Easy maintenance:** The equipment allows for testing without the need to stop any ongoing processes.
- **Small size of 22.5 mm:** The D30 relay is also known for its small size. It is ideal for manufacturers of MCC's which have limited panel space.
- **Versatile:** Positive or negative logic can be selected making the relay more flexible at use.

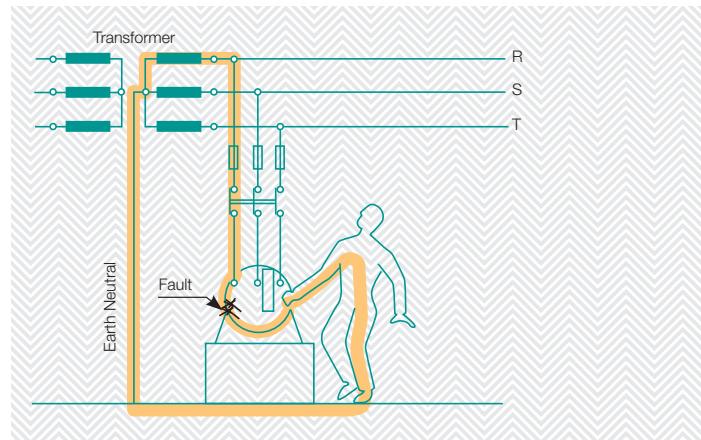
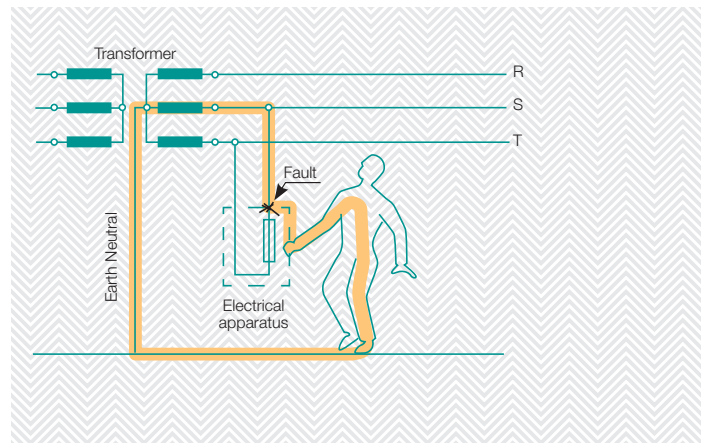

Selection guide

EARTH LEAKAGE RELAYS

MODELS	V. AUX.	DESCRIPTION
D30	120 Vac	Multirange Earth Leakage Relay 22,5 mm
D30	230 Vac	Multirange Earth Leakage Relay 22,5 mm
DM30	24-230 Vdc-ac	Superimmunized Multirange Relay
DR30F	120 Vac	Superimmunized Multirange Relay Automatic reclosing Defined time
DR30F	230 Vac	Superimmunized Multirange Relay Automatic reclosing Defined time
DR30A	120 Vac	Superimmunized Multirange Relay Automatic reclosing Adjustable time
DR30A	230 Vca	Superimmunized Multirange Relay Automatic reclosing Adjustable time
ELR-B	24-48 Vdc-ac	Earth Leakage Relay
ELR-B	110 V Vdc-ac / 230-400 Vdc-ac	Earth Leakage Relay
ELR-3C	24-48 Vdc-ac	Multirange Earth Leakage Relay
ELR-3C	110 V Vdc-ac / 230-400 Vdc-ac	Multirange Earth Leakage Relay
ELR-3C-F2	24 Vdc	Superimmunized multirange relay 2 output contacts
ELR-A	24-48 Vdc-ac	Earth Leakage Relay Built-in TT Ø28mm
ELR-A	110 V Vdc-ac / 230-400 Vdc-ac	Earth Leakage Relay Built-in TT Ø28mm
ELR-T60	24-48 Vdc-ac	Earth Leakage Relay Built-in TT Ø60mm
ELR-T60	110 V Vdc-ac / 230-400 Vdc-ac	Earth Leakage Relay Built-in TT Ø60mm
ELR-T110	24-48 Vdc-ac	Earth Leakage Relay Built-in TT Ø110mm
ELR-T110	110 V Vdc-ac / 230-400 Vdc-ac	Earth Leakage Relay Built-in TT Ø110mm

EARTH LEAKAGE TRANSFORMERS

MODELS	DESCRIPTION
CTD - 1 / 28	Toroidal trasformer Din →28mm
CT-1 / 35	Toroidal transformer →35mm
CT-1 / 60	Toroidal transformer →60mm
CT-1 / 80	Toroidal transformer →80mm
CT-1 / 110	Toroidal transformer →110mm
CT-1 / 160	Toroidal transformer →160mm
CT-1 / 210	Toroidal transformer →210mm
CT-1 / 350	Toroidal transformer →350mm
CT-1 / 400	Toroidal transformer →400mm
CTA-1 / 110	Toroidal open transformer →110mm
CTA-1 / 160	Toroidal open transformer →160mm
CTA-1 / 210	Toroidal open transformer →210mm

Earth Leakage Relays WITH BUILT-IN Toroidal Transformer

MULTIRANGE RELAY

- Electronic relays with adjustable time delay and sensitivity.
- Suitable for direct pulse current.
- Immune to external disturbances.
- Sensitivity from 0,025 to 25A.
- Trip time delay from 0,02 to 5s.
- Modular size. DIN rail mounting.
- Protection front cover.

ELR-A



MULTIRANGE RELAY

- Electronic relays with adjustable time delay and sensitivity.
- Suitable for direct pulse current.
- Immune to external disturbances.
- Sensitivity from 0,025 to 25A.
- Trip time delay from 0,02 to 5s.
- Compact device. Suitable for motor control centers (MCC).

ELR-T



MODELS	ELR-A		ELR-T60		ELR-T110	
Sensitivity	Adjustable from 0,025 A to 25 A		Adjustable from 0,025A to 25 A			
Trip time delay	Adjustable from 0,02 s to 5 s		Adjustable from 0,02 s to 5 s			
Aux. voltage supply 50/60 Hz	24-48 Vdc, ac	110 Vdc, ac	24-48 Vdc, ac	110 Vdc, ac	24-48 Vdc, ac	110 Vdc, ac
		230-400 Vac		230-400 Vac		230-400 Vac
Code	41017	41015	41107	41105	41102	41100

DIMENSIONS (mm)

ELR-A

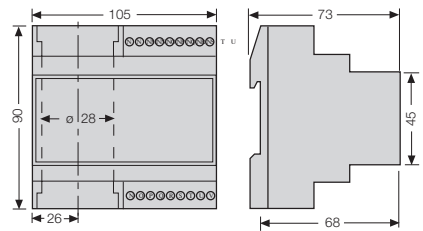

ELR-T

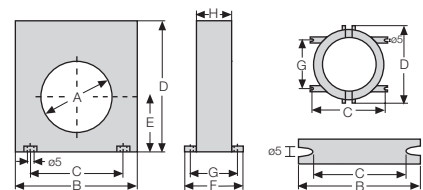

	A	B	C	D	E	F	G	H	K
ELR-T60	60	100	60	110	47	70	60	50	-
ELR-T110	110	150	110	160	70	70	60	50	-

CHARACTERISTICS	
Toroidal transformer	ELR-A: Built-in Ø28 mm / ELR-T: Built-in Ø60 mm and Ø110 mm
Max. length between relay and transformer	-
Reset mode	Automatic, manual and remote (in manual mode disconnect the aux. supply during 1s)
Signalling LED's	2 LED's: ON + Trip
Output contacts mode	ELR-A: Selectable: normally de-energized or energized ELR-T: Normally de-energized
Output contacts	ELR-A: 2 change over NO-NC / ELR-T: 1 change over NO-NC
Switching power (resistive load)	5A - 250V
Maximum terminal section	2,5 mm ²
Maximum consumption	3 VA
Modular size	ELR-A: 6 modules x 17,5 mm = 105 mm / ELR-T: No
Frequency	50/60 Hz
Protection degree / weight	ELR-A: IP-20 / 0,4 kg / ELR-T: IP-20 / 0,4 y 0,6 kg
Storage / operation temperature	-10°C +60°C
Standards	IEC 41-1, IEC 255, VDE 0664, EN 50081-1, EN 50082-2

WIRING DIAGRAM

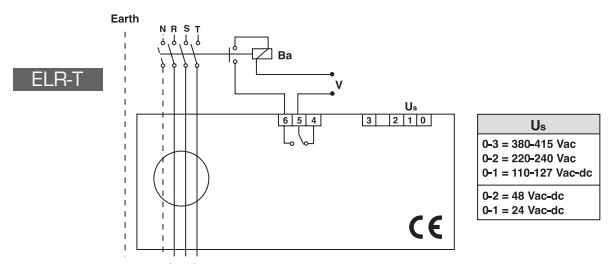
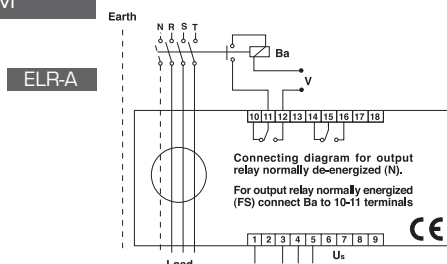

Earth Leakage Relays WITHOUT BUILT-IN Toroidal Transformer

RELAY WITH ADJUSTABLE DELAY TIME AND SENSITIVITY

- Electronic relays with adjustable time delay and sensitivity.
- Suitable for direct pulse current.
- Immune to external disturbances.
- To be used with CT-1 and CTD-1 toroidal transformers (See page 137).
- Modular size. DIN rail mounting.
- Sealable front cover.

ELR-B



MULTIRANGE RELAY

- Electronic relays with adjustable time delay and sensitivity.
- Suitable for direct pulse current.
- Immune to external disturbances.
- To be used with CT-1 and CTD-1 toroidal transformers (See page 137).
- Modular size. DIN rail mounting.
- Sealable front cover.

ELR-3C



MODELS	ELR-B		ELR-3C	
Sensitivity	0,3 A or 0,5 A		Adjustable from 0,025 A to 25 A	
Trip time delay	0,02 s or 0,5 s		Adjustable from 0,02 s to 5 s	
Aux. voltage supply 50/60 Hz	24-48 Vdc, ac	110 Vdc, ac	24-48 Vdc, ac	110 Vdc, ac
		230-400 Vac		230-400 Vac
Code	41012	41010	41005	41000

DIMENSIONS (mm)

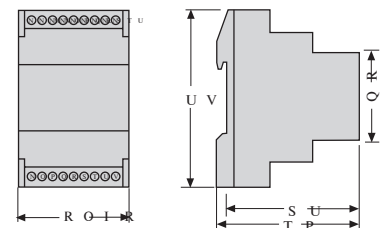

CHARACTERISTICS	
Toroidal transformer	In combination with CT-1
Max. length between relay and transformer	20 m with cables twisted
Reset mode	Automatic, manual and remote (in manual mode disconnect the aux. supply during 1s)
Signalling LED's	2 LED's: ON + Trip
Output contacts mode	Normally de-energized
Output contacts	1 change over NO-NC
Switching power (resistive load)	5A - 250V
Maximum terminal section	2,5 mm ²
Maximum consumption	3 VA
Modular size	3 modules x 17,5 mm = 52,5 mm
Frequency	50/60 Hz
Protection degree / weight	IP-20 / 0,2 kg
Storage / operation temperature	-10°C +60°C
Standards	IEC 41-1, IEC 255, VDE 0664, EN 50081-1, EN 50082-2

WIRING DIAGRAM

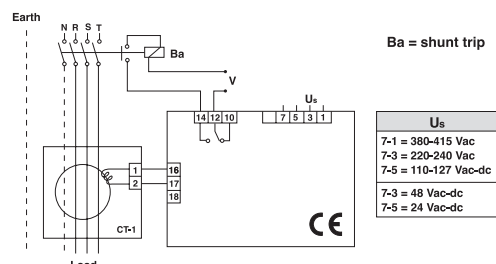

D30 / DM30

Earth Leakage Relays WITHOUT BUILT- IN Toroidal Transformer

D30 - SUPERIMMUNIZED MULTIRANGE RELAY 22,5 mm

- Electronic relays with adjustable time delay and sensitivity.
- Suitable for direct pulse current.
- Immune to external disturbances.
- Suitable for systems with and without neutral.
- Very high level of immunity.
- 22.5 mm wide. Saving space in the distribution board.
- DIN rail mounting.
- To be used with CT-1 and CTD-1 toroidal transformers.
- Suitable for Motor Control Centers (MCC), electrical distribution boards and control panels in general.

DM30 - SUPERIMMUNIZED MULTIRANGE RELAY

- Electronic relays with adjustable time delay and sensitivity.
- Suitable for direct pulse current.
- Immune to external disturbances.
- Suitable for systems with and without neutral.
- Very high level of immunity.
- Modular size. DIN rail mounting.
- To be used with CT-1 and CTD-1 toroidal transformers.
- Suitable for electrical distribution boards and control panels in general.
- Sealable front cover

D30



DM30



MODELS	D30		DM30
Sensitivity	Adjustable from 0.03 A to 30 A		Adjustable from 0.03 A to 30 A
Trip time delay	Adjustable from 0.02 s to 5 s		Adjustable from 0.02 s to 5 s
Aux. voltage supply 50/60 Hz	120 Vac ± 15%	230 Vac ± 15%	24-230 Vac/dc (-20%/+10%)
Code	41021	41020	11500

CHARACTERISTICS			
Toroidal transformer	In combination with CT-1		
Max. length between relay and transformer	Cable section mm ²		
	0,22 mm ²	0,75 mm ²	1 mm ²
Max. length between relay and transformer	Max. length m		
	15 m	55 m	75 m
Reset mode	Automatic, manual and remote (in manual mode disconnect the aux. Supply during 1s)		
Signalling LED's	2 LED's: ON + (trip)		
Output contacts mode	Selectable: normally de-energized (N) or energized (P)		
Output contacts	1 change over NO-NC		
Switching power (resistive load)	I _{th} : 5A; AC15 - 250V - 2A; DC13 - 30V - 2A		
Maximum terminal section	2,5 mm ²		
Maximum consumption	7 VA - 230 V	2,5 VA (120 - 230 V)	
Modular size	No. 22,5 mm wide	3 modules x 17,5 mm = 52,5 mm	
Frequency	50/60 Hz		
Protection degree / weight	IP-20 / 0,2 kg		
Storage / operation temperature	-10°C +60°C		
Class	A		
Standards	EN 50263, EN 61543 (A11), EN 60255-5, VDE 0664, 61008-1/A14, 61000-4-11		

DIMENSIONS (mm)

D30

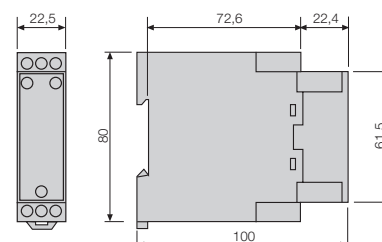

DM30

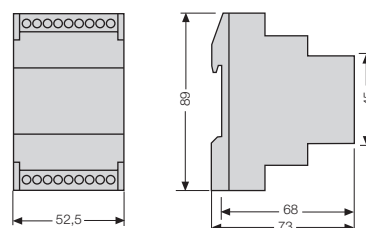

WIRING DIAGRAM

D30

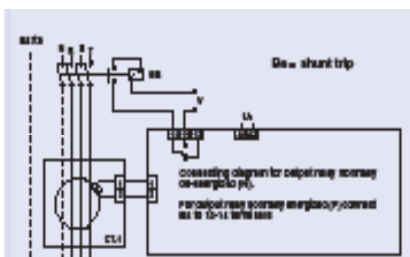

DM30

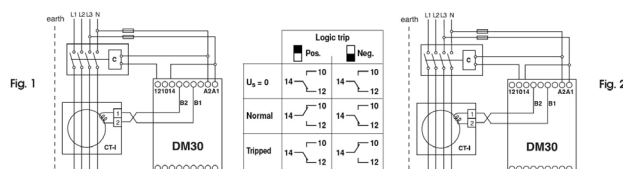

	C Undervoltage trip coil Contactor	C Shunt trip coil	Logic trip
Safety priority	Fig. 2	Fig. 1	Posit. <input type="checkbox"/> P
Service priority	Fig. 1	Fig. 2	Negat. <input type="checkbox"/> N

SUPERIMMUNIZED MULTIRANGE RELAY WITH AUTOMATIC RECLOSING

- Electronic relays with automatic reclosing up to 3 attempts with defined (1 m) or adjustable (1 to 60 s) time.
- Adjustable time delay and sensitivity.
- Suitable for direct pulse current.
- Immune to external disturbances.
- Suitable for systems with and without neutral.
- Very high level of immunity.
- Modular size. DIN rail mounting.
- To be used with CT-1 and CTD-1 toroidal transformers (See page 137).
- Suitable for electrical distribution boards in general.
- Sealable front cover.

DR30F



DR30A



MODELS	DR30F			DR30A		
Reclosing time	60 s			Adjustable from 1 s to 60 s		
Sensitivity	Adjustable from 0,03 A to 30 A					
Trip time delay	Adjustable from 0,02 s to 5 s					
Aux. voltage supply 50/60 Hz	120 Vac±15%	230 Vac±15%	24 Vdc	120 Vac±15%	230 Vac±15%	24 Vdc±15%
Code	41026	41024	41027	41028	41019	41029

CHARACTERISTICS	
Toroidal transformer	In combination with CT-1
Max. length between relay and transformer	Cable section mm ²
	0,22 mm ² 0,75 mm ² 1 mm ² 1,5 mm ²
	Max. length m
	15 m 55 m 75 m 110 m
Reset mode	Automatic, manual and remote (in manual mode disconnect the aux. Supply during 1s)
Signalling LED's	2 LED's: ON + $\frac{1}{2}$ (trip) / 2 LED's: Numbers of reclosing / 4 LED's: % measurement
Output contacts mode	Selectable: normally de-energized (N) or energized (P)
Output contacts	2 change over NO-NC
Switching power (resistive load)	I_{th} : 5A; AC15 - 250V - 2A; DC13 - 30V - 2A
Maximum terminal section	2,5 mm ²
Maximum consumption	2,5 VA - 230 V
Modular size	3 modules x 17,5 mm = 52,5 mm
Frequency	50/60 Hz
Protection degree / weight	IP-20 / 0,2 kg
Storage / operation temperature	-10°C +60°C
Standards	EN 50263, EN 61543 (A11), EN 60255-5, VDE 0664, 61008-1/A14, 61000-4-11

DIMENSIONS (mm)

DR30

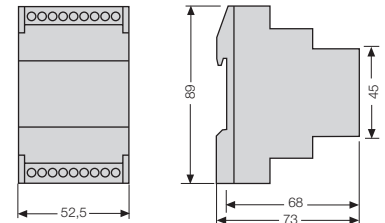

WIRING DIAGRAM

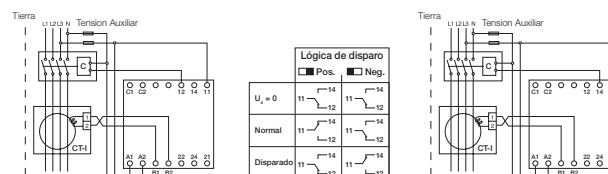

	C Undervoltage trip coil Contactor	C Shunt trip coil	Trip Logic
Safety Priority	Fig. 2	Fig. 1	Posit. N <input type="checkbox"/> P
Service Priority	Fig. 1	Fig. 2	Negat. N <input type="checkbox"/> P

CT-1 / CTD-1

Toroidal Transformers for Earth Leakage Relays

FOR EARTH LEAKAGE RELAYS WITH OUT BUILT-IN TOROIDAL TRANSFORMERS

- To be used with ELR-B, ELR-3C, D30, DM30 and DR30 relays.
- The transformer and relay assembly sensitivity is fixed by the relay.
- The toroidal transformer CTD-1/28 is specifically designed for DIN rail mounting.

Thermoplastic material	UL94-VO
Operating frequency	47-63 Hz
Insulation	2,5 kV 50 Hz, 1 min
Protection degree	IP20
Continuous overload	1000A
Thermal overload	40 kA (1sec)
Operating temperature	From 0 to +50°C U.R/R.H <90% n.c.
Storage temperature	From -20 to 70°C
Connections	Screw, Max 1,5 mm ²

CT-1 CE



CT-1/35...210



CT-1/300
CT-1/350

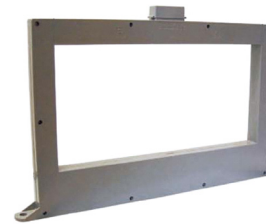

CT-1/400



CTD-1/28

DIMENSIONS (mm) AND WEIGHT (KG.)

Type	Code	Core	a	b	c	d	e	f	g	h	i	Weight	Inner
CT-1/35	41060	Closed	35	88	73	92	100	-	40	6	28	0,2	-
CT-1/60	41065	Closed	60	112	98	116	125	-	55	6	28	0,3	-
CT-1/80	41070	Closed	80	132	118	136	146	-	65	6	28	0,5	-
CT-1/110	41075	Closed	110	158	148	166	178	-	78	6	28	0,5	-
CT-1/160	41080	Closed	160	265	255	265	275	-	130	8,5	45	1,4	-
CT-1/210	41085	Closed	210	315	305	310	325	-	155	8,5	45	1,5	-
CT-1/300	41088	Closed	300	385	364	-	-	-	187	-	51+10	4,4	-
CT-1/350	41090	Closed	350	445	434	-	-	-	217	-	41+10	4,8	-
CT-1/400	41092	Closed	270	410	475	463	28	170	351	66	-	8,3	-
CTA-1/60	41066	Open	60	125	116	13	140	45	60	8,5	34	0,3	-
CTA-1/110	41076	Open	110	215	205	220	235	70	105	8,5	40	0,5	-
CTA-1/160	41081	Open	160	265	255	265	275	75	130	8,5	45	1,4	-
CTA-1/210	41086	Open	210	315	305	310	325	75	155	8,5	45	1,5	-
CTD-1/28	41055	-	-	-	-	-	-	-	-	-	-	0,2	28mm

CTD-1/28

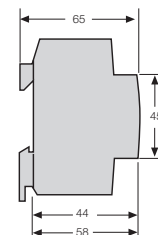
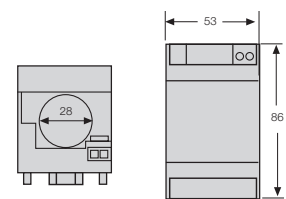

CT-1/35...210

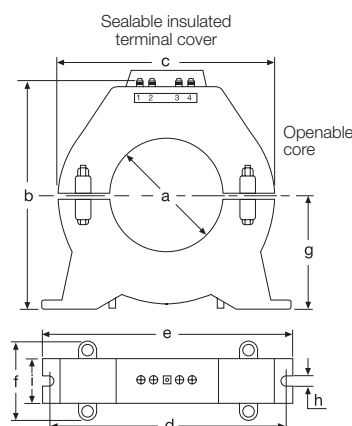
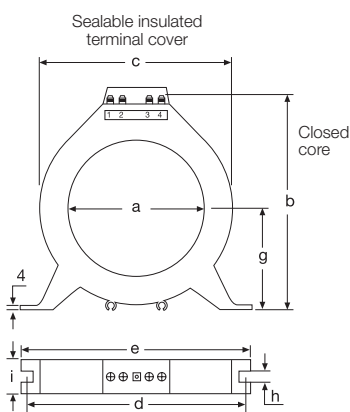

CT-1/300
CT-1/350

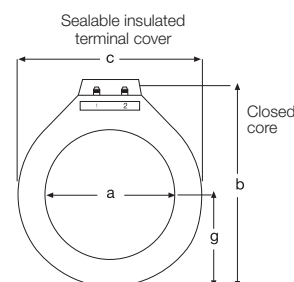

CT-1/400

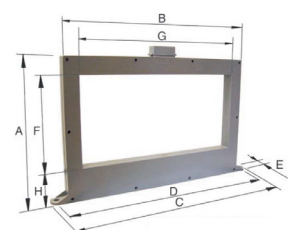

Safely protected



SURGE PROTECTION

Introduction

The surge protection relays protect installations and eliminate the effects of power surges. They offer the highest level of security in low voltage lines, continuous processes, domestic and tertiary facilities, etc.

They are suitable for manufacturers and system integrators of industrial equipment, photovoltaic applications, wind turbines, etc.

Devices connected to the mains are increasingly susceptible to electrical disturbances in the grid. Hence it is essential to provide adequate protection to avoid major economic and material losses.

The most visible and destructive power surges are often caused by atmospheric discharges (lightning strikes). However, this is not the most common source of such disturbances, as in most cases, the main sources of surges are within the facility installation itself, amongst others for the following reasons:

- Performance of circuit breakers and fuses.
- Connection and disconnection of inductive loads.
- Switching of motors and machines.
- Electrostatic discharge.
- Capacitor's power factor correction.
- Energy transfers in generator sets.

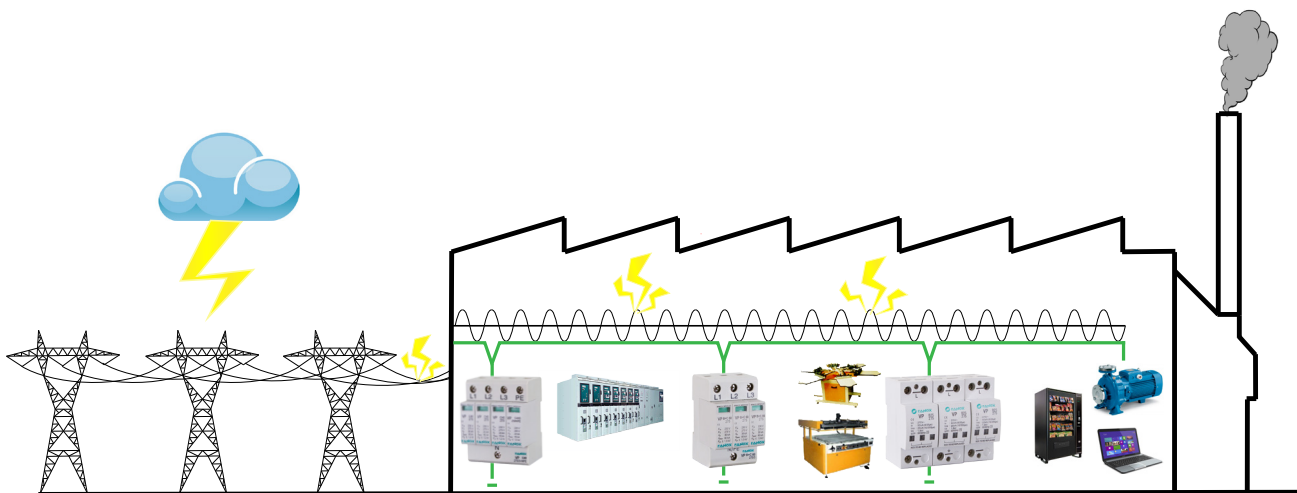

Selection guide

CLASS C - TYPE II

MODELS	DECIPTION						
	SOLAR	WIND POWER	INDICATOR	Uc	Up	In	Imax
VP C40 275/1			✓	275 V	< 1,2 kV	20 kA	40 kA
VP C40 250/NPE			✓	250 V	< 1,5 kV	20 kA	40 kA
VP C40 275/2			✓	275 V	< 1,2 kV	20 kA	40 kA
VP C40 275/1+ NPE			✓	275 V	< 1,2 kV	20 kA	40 kA
VP C40 275/3			✓	275 V	< 1,2 kV	20 kA	40 kA
VP C40 275/2+ NPE			✓	275 V	< 1,2 kV	20 kA	40 kA
VP C40 275/4			✓	275 V	< 1,2 kV	20 kA	40 kA
VP C40 275/3+ NPE			✓	275 V	< 1,2 kV	20 kA	40 kA
VP C40 PV500	✓		✓	500 Vcc	< 1,8 kV	20 kA	40 kA
VP C40 PV1000	✓		✓	1000 Vcc	< 3,6 kV	20 kA	40 kA
VP C20 275/1+ NPE				275 V	< 1,0 kV	10 kA	20 kA
VP C20 275/3+ NPE				275 V	< 1,0 kV	10 kA	20 kA
VP C30 600/3		✓	✓	600 V	< 2,8 kV	15 kA	30 kA

PLUG-IN MODULES

MODELS	DECIPTION						
	SOLAR	WIND POWER	INDICATOR	Uc	Up	In	Imax
VP C40 275				275 V	1,2 kV	20 kA	40 kA
VP C40G 250 NPE				250 V	1,5 kV	20 kA	40 kA
VP C40 250	✓			250 Vcc	0,9 kV	20 kA	40 kA
VP C40 500	✓			500 Vcc	1,8 kV	20 kA	40 kA
VP C20 275				275 V	1,0 Kv	10 kA	20 kA
VP C20G 250 NPE				275 V	1,0 Kv	10 kA	20 kA
VP C30 600		✓		600 V	2,8 Kv	15 kA	30 kA

CLASS B+C - TYPE I + II

MODELS	DECIPTION						
	SOLAR	WIND POWER	INDICATOR	Uc	Up	In	Imax
VP B+C60 255/NPE			✓	275 V	< 1,5 kV	30 kA	60 kA
VP B+C60 275/1			✓	250 V	< 1,5 kV	30 kA	60 kA
VP B+C60 275/1+NPE			✓	275 V	< 1,2 kV	30 kA	60 kA
VP B+C60 275/2			✓	275 V	< 1,2 kV	30 kA	60 kA
VP B+C60 275/2+NPE			✓	275 V	< 1,2 kV	30 kA	60 kA
VP B+C60 275/3			✓	275 V	< 1,2 kV	30 kA	60 kA
VP B+C60 275/4			✓	275 V	< 1,2 kV	30 kA	60 kA
VP B+C60 275/3+NPE			✓	275 V	< 1,2 kV	30 kA	60 kA

CLASS B - TYPE I

MODELS	DECIPTION						
	SOLAR	WIND POWER	INDICATOR	Uc	Up	In	Imax
VP B25 255/NPE			✓	255 V	< 1,8 kV	50 kA	100 kA
VP B25 275/1			✓	250 V	< 1,8 kV	50 kA	25 kA
VP B25 275/1+NPE			✓	275 V	< 1,8 kV	50 kA	25 kA
VP B25 275/2			✓	275 V	< 1,8 kV	50 kA	25 kA
VP B25 275/2+NPE			✓	275 V	< 1,8 kV	50 kA	25 kA
VP B25 275/3			✓	275 V	< 1,8 kV	50 kA	25 kA
VP B25 275/3+NPE			✓	275 V	< 1,8 kV	50 kA	25 kA
VP B25 275/			✓	275 V	< 1,8 kV	50 kA	25 kA

CLASS B - TYPE I

MODELS	DECIPTION						
	SOLAR	WIND POWER	INDICATOR	Uc	Up	In	Metal
SST480D200AF/M	480 V	✓	✓	550 V	< 2,2 kV	200 kA	✓
SST120SP200AF/9	120/240 V	✓	✓	150/300 V	< 1,2 kV	200 kA	✓

Power Supply Systems & Installations

SURGES TYPE B (CLASS I)

- Compact equipments for all distribution systems.
- High discharge capacity by "Spark Gap" technology.
- Visual indication of a fault in the equipment.
- With thermal separation device.
- Remote signalling of the protection status.



CE

Code	POWER SUPPLY NETWORK							
	41648	41642	41643	41644	41645	41646	41641	41647
Model	VP B25 255/NPE	VP B25 275/1	VP B25 275/1+NPE	VP B25 275/2	VP B25 275/2+NPE	VP B25 275/3	VP B25 275/3+NPE	VP B25 275/4
According to IEC 61643-1 (Class)	Class I							
Type of network	TT	TT/TN	TT/TN	TN	TT/TN	TN	TT/TN	TN
Electrical line	-	1P+NPE	1P+N+PE	1P+N+PE 2P+NPE	2P+N+PE	2P+N+PE 3P+PE 3P+NPE	3P+N+PE 3P+PE	3P+N+PE
Nominal voltage Un (Vac)	230 Vac							
Maximum continuous operating voltage Uc (Vac)	255 Vac	275 Vac						
Nominal discharge current (8/20 μs) In (kA)	50 kA							
Maximum discharge current (8/20 μs) I_{max} (kA)	100 kA							
Impulse current (10/350 μs) I_{imp} (kA)	25 kA							
Protection level Up (kV) at 30 kA	< 1,8 kV							
Response time ta (ns)	< 100 ns	< 25 ns						
Maximum back-up fuse (A gL/gG)	160							
N° Modules	1	2		3		4		

Power Supply Systems & Installations

SURGES TYPE B+C (CLASS I+II)

- Compact equipments for all distribution systems.
- High discharge capacity by "Spark Gap" technology.
- Visual indication of a fault in the equipment.
- With thermal separation device.
- Remote signalling of the protection status.
- Plug-in protection modules which facilitate maintenance.



Code	POWER SUPPLY NETWORK							
	41631	41632	41633	41636	41637	41638	41639	41640
Model	B+C60 255/NPE	B+C60 255/1	B+C60 275/1+NPE	B+C60 275/2	B+C60 275/2+NPE	B+C60 275/3	B+C60 275/4	B+C60 275/3+NPE
According to IEC 61643-1 (Class)	I+II (Class)							
Type of network	TT	TT/TN	TT/TN	TN	TT/TN	TN	TN	TT/TN
Electrical line	-	1P+NPE	1P+N+PE	1P+N+PE 2P+NPE	2P+N+PE	2P+N+PE 3P+PE 3P+NPE	3P+N+PE	3P+N+PE 3P+PE
Nominal voltage U_n (Vac)	230 Vac							
Maximum continuous operating voltage U_c (Vac)	255 Vac	275 Vac						
Nominal discharge current (8/20 μs) I_n (kA)	30 kA							
Maximum discharge current (8/20 μs) I_{max} (kA)	60 kA							
Protection level U_p (kV) at 30 kA	< 1,5 kV							
Response time t_a (ns)	< 25 ns							
Maximum back-up fuse (A gL/gG)	125							
N° Modules	1	2		3		4		

Power Supply Systems & Installations

SURGES TYPE C (CLASS II)

- Compact equipments for all distribution systems.
- High discharge capacity via zinc oxide varistors and gas dischargers.
- With thermal separation device.
- Visual indication of a fault in the equipment.
- Remote signalling of the protection status.
- Plug-in protection modules which facilitate maintenance.



Code	POWER SUPPLY NETWORK									
	41600	41602	41603	41604	41607	41606	41610	41609	41624	41625
Model	VP C40 275/1	VP C40 250/NPE	VP C40 275/2	VP C40 275/1+NPE	VP C40 275/3	VP C40 275/2+NPE	VP C40 275/4	VP C40 275/3+NPE	VP C20 275/1+NPE	VP C20 275/3+NPE
According to IEC 61643-1 (Class)	Class II									
Type of network	TT/TN	TT	TN	TT/TN	TN	TT/TN	TN	TT/TN		
Electrical line	1P+NPE (1) (2) (3)	1P+N+PE 2P+N+PE 3P+N+PE 3P+PE	1P+N+PE 2P+NPE	1P+N+PE	2P+N+PE 3P+PE 3P+NPE	2P+N+PE	3P+N+PE	3P+N+PE 3P+PE	1P+N+PE	3P+N+PE 3P+PE
Nominal voltage Un (Vac)	230 Vac									
Maximum continuous operating voltage Uc (Vac)	275 Vac	250 Vac	275 Vac							
Nominal discharge current (8/20 μs) In (kA)	20 kA							10		
Maximum discharge current (8/20 μs) Imax (kA)	40 kA							20		
Protection level Up (kV)	< 1,2 kV	< 1,5 kV	< 1,2 kV					< 1,0 kV		
Protection level at 5 kA (kV)	< 1,0 kV	--	< 1,0 kV					< 0,95 kV		
Response time ta (ns)	< 25 ns	<100 ns	< 25 ns							
Maximum back-up fuse (A gL/gG)	125	--	125					100		
N° Modules	1	1	2	2	3	3	4	4	2	4
Plug-in modules code	41611	41612	41611	41611/41612	41611	41611/41612	41611	41611/41612	41626/41627	41626/41627

By using individual devices instead of compact ones, they can be installed in:

(1) TN-S System:

- 2 units of VP C40 275/1 → 1P+N+PE
- 3 units of VP C40 275/1 → 2P+N+PE or 3P+PE
- 4 units of VP C40 275/1 → 3P+N+PE

(3) TT System:

- 1 unit of VP C40 275/1 + 1 unit VP C40 250/NPE → 1P+N+PE
- 2 units of VP C40 275/1 + 1 unit VP C40 250/NPE → 2P+N+PE
- 3 units of VP C40 275/1 + 1 unit VP C40 250/NPE → 3P+N+PE or 3P+PE

(2) TN-C System:

- 2 units of VP C40 275/1 → 2P+NPE
- 3 units of VP C40 275/1 → 3P+NPE

TYPE B (Class I)



TYPE B + C (Class I+II)



TYPE C (Class II)



WIRING DIAGRAM

TN-S SYSTEM

3F + N + PE

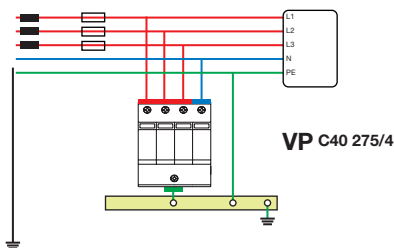

TN-C SYSTEM

3F + NPE

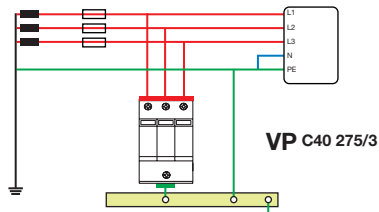

TT SYSTEM

3F + N

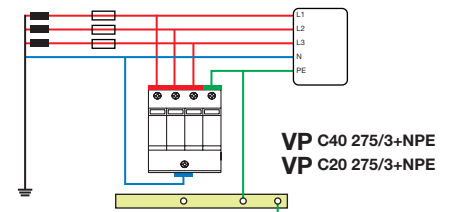

DIMENSIONS (mm)

TYPE B (Class I)

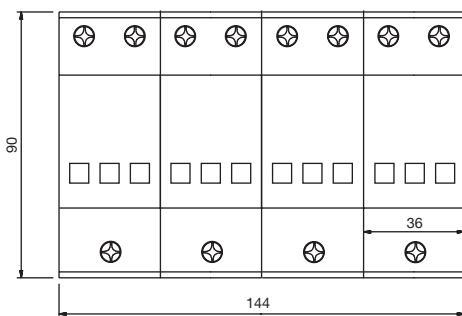

*Width depending on number of modules

TYPE B + C (Class I+II) and TYPE C (Class II)

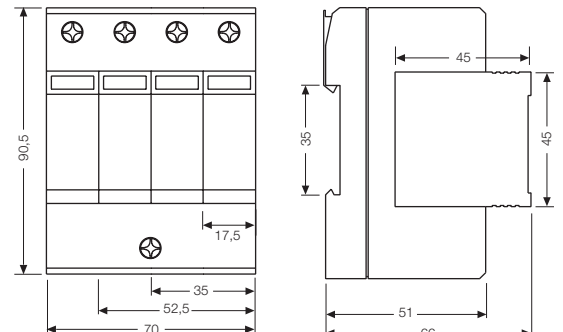

*Width depending on number of modules

PHOTOVOLTAIC Applications

- Compact equipment for photovoltaic installations.
- High discharge capacity via zinc oxide varistors and gas dischargers.
- With thermal separation device.
- Visual indication of a fault in the equipment.
- Remote signalling of protection status.
- Plug-in protection modules which facilitate maintenance.



Code	PHOTOVOLTAIC APPLICATIONS	
	41605	41608
Model	VP C40 PV500	VP C40 PV1000
According to IEC 61643-1 (Class)	II	
Photovoltaic line	2F+PE	2F+PE
Maximum service voltage in direct current U_{oc_max} (Vdc)	< 500	< 1000
Maximum continuous operating voltage U_c (L-PE) (Vdc)	250	500
Nominal discharge current (8/20 μ s) I_n (kA)	20	
Maximum discharge current (8/20 μ s) I_{max} (kA)	40	
Protection level U_p (kV)	< 1,8	< 3,6
Protection level at 5 kA (kV)	< 1,5	< 3
Response time t_a (ns)	< 25	< 25
Maximum back-up fuse (A gL/gG)	125	125
N° Modules	3	3
Plug-in modules code	41614	41616

DIMENSIONS (mm)

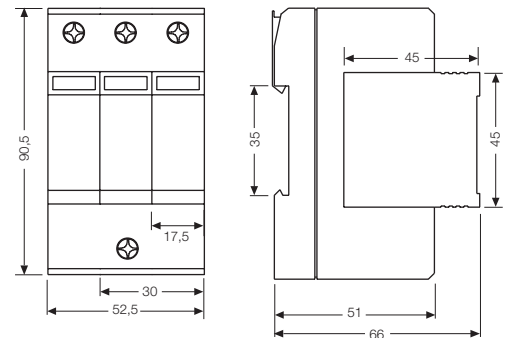

WIRING DIAGRAM

TN-S SYSTEM

3F + N + PE

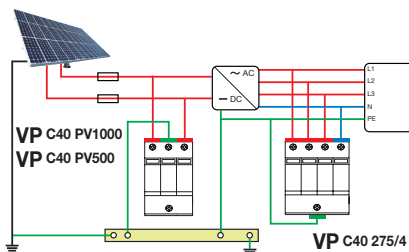

TN-C SYSTEM

3F + NPE

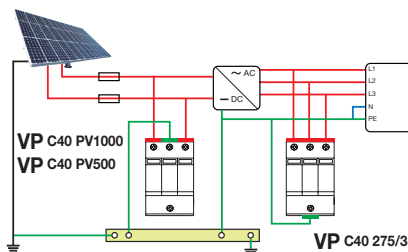

TT SYSTEM

3F + N

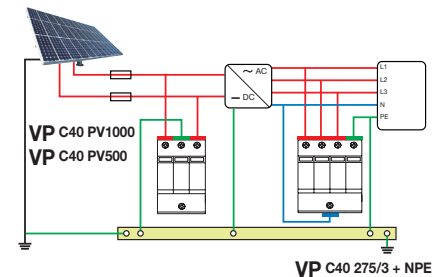

WIND Power Applications

- Compact equipment for wind power installations.
- High discharge capacity via zinc oxide varistors and gas dischargers.
- With thermal separation device.
- Visual indication of a fault in the equipment.
- Remote signalling of protection status.
- Plug-in protection modules which facilitate maintenance.



WIND POWER APPLICATIONS	
Code	41622
Model	VP C30 600/3
According to IEC 61643-1 (Class)	II
Type of network	TT/TN
Eolic line	2F+N+PE
	3F+PE
	3F+NPE
Nominal voltage Un (Vca)	600
Maximum continuous operating voltage Uc (Vca)	600
Nominal discharge current (8/20 μs) In (kA)	15
Maximum discharge current (8/20 μs) Imax (kA)	30
Protection level Up (kV)	< 2,8
Protection level at 5 kA (kV)	< 2,4
Response time ta (ns)	< 25
Maximum back-up fuse (A gL/gG)	63
N° modules	3
Plug-in modules code	41623

DIMENSIONS (mm)

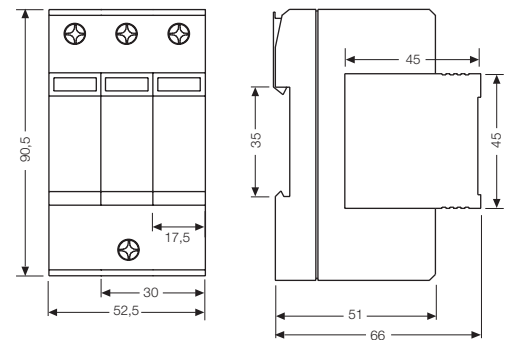

WIRING DIAGRAM

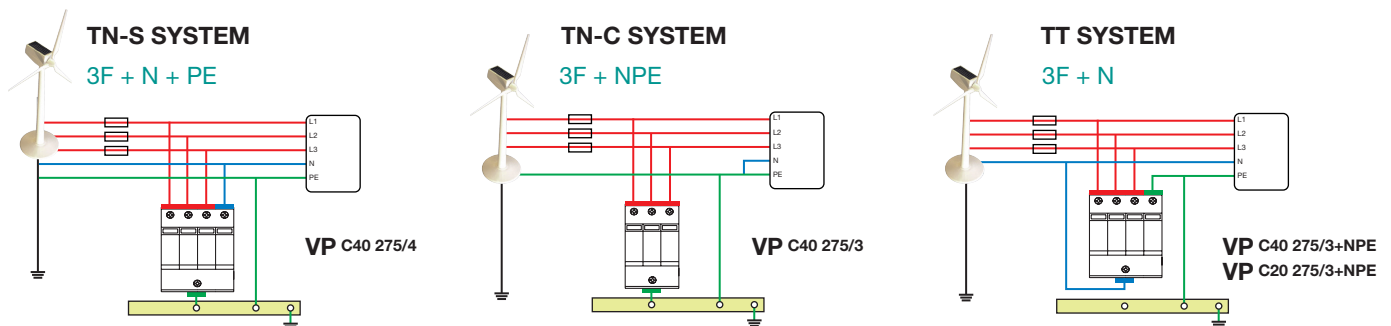

Protection against Transient Overvoltage

SURGE ARRESTERS

Surge arrester for low voltage power supply systems. Protection against transient overvoltage that may arise in the electrical supply, at the boundaries

from lightning protection zone 0B-1 and higher.

- UL 1449 3rd with SCCR 200KArms.
- MOV technology, high energy discharge capacity.
- Thermally protected.
- Visual fault indication
- Remote signalling.
- Low voltage protection level.
- Metallic box.
- Surge event counter.
- Failure pre-test.
- Filtering function.

Ideal for applications with low discharge capacity required such as:

- Instalations with electronic equipments and microprocessor-based systems.
- Switchboards.
- Secondary panels.

SST



CE

TECHNICAL PARAMETERS

Model	SST480D200AF/M
Nominal voltage	480 V
Discharge capacity	200 KA
Maximum continuous operating voltage Uc	550 V
Current counter	≥ 200 A (Reset button)
Failure pre-test	Press 2S (Test button)
Filtering	L-N, N-PE, L = PE
Power status indication	LED ON encendido = OK
Working status indication	LED ON Blue = OK ; Blue LED ON Azul OFF y Red LED ON = FAILURE
Power connecting cable	8 AWG L1 = Yellow L2 = Green L3 = Red N = Blue/Brown PE = Black
Signal cable	16 AWG C = Red NC = Blue NO = Brown
Working temperature range	-40°C + 70°C
Working humidity relative	5-95% (25°C)
Working altitude	≤ 2 km
Dimensions W x D x H (mm)	256 x 205 x 104
Net weight	5,4 Kg

DISTRIBUTION DIAGRAM

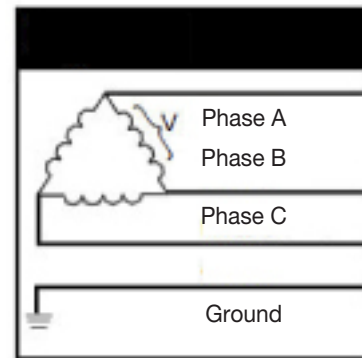

3 Hots + Grnd

	L-N	L-L	L-G
Nominal voltage level	N/A	480	480
Voltage protection ratings (VPR @6KV/ 3kA)	N/A	2200	1900

Other models available

OTHER MODELS AVAILABLE

Code configuration for other models is done as follows:

Code: SST / P (Plastic) or M (Metal)

Optional functions:

C= Surge counter

T= Failure test

A= Remote alarm

F= Noise filtering

Max. surge current per phase (from 50KA - 300 KA/Phase)

Voltage for power distribution system

Figures	Distribution diagrams	L-N	L-L	L-G	Model
Figure 1	2 Hots + 1 Neu + 1 Grnd (2L+N+G)	120	240	120	120SP
Figure 2	3 Hots + 1 Neu + 1 Grnd (3L+N+G)	127	220	127	127Y
		220	380	220	220Y
		240	415	240	240Y
		277	480	277	277Y
Figure 2	3 Hots + 1 Neu + 1 Grnd (3L+N+G)	347	600	347	347Y
		347	600	347	347Y
Figure 3	3 Hots + (B-HIGH) + 1 Neu + 1 Grnd (3L+N+G)	120	240	120	120H
Figure 4	3 Hots + Grnd (3L+G)	N/A	240	240	240D
		N/A	480	480	480D
		N/A	600	600	600D
Figure 5	1 Hot + 1 Neu + 1 Grnd (L+N+G)	127	N/A	127	127S
		240	N/A	240	240S

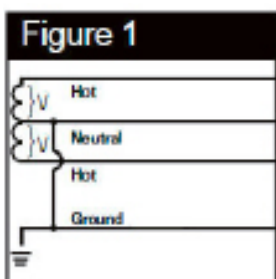

SPLIT

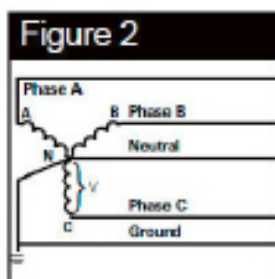

WYE

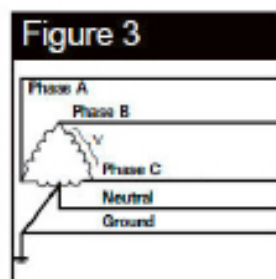

HI-LEG DELTA (B High)

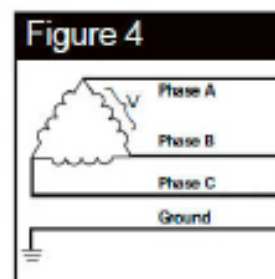

DELTA & HRG WYE

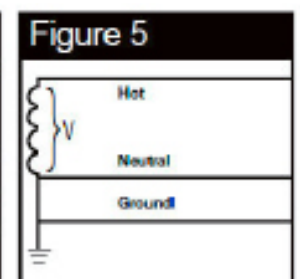

SINGLE POLE

**“We fulfill our
customers necessities
adapting our product.
We give solutions”**

CUSTOMIZED PRODUCTS AND BRAND LABELING

Introduction

Every day an increasing number of companies are considering the option of outsourcing their design and product development.

Fanox is the perfect technology partner to carry out these activities. Our R & D department is prepared to operate as an integral part of our clients business – adapting to their needs by developing custom designs.

Fanox is a leader in the customization of products for reputable manufacturers, and we offer added value at a very competitive price. Fanox provides additional performance characteristics to the equipment thanks to continuous improvement of electronics – spear heading a rapidly moving technology sector.

We have **high expertise** in the area of **electronics** related to:

- Protection
- Control
- Measurement
- Communication

We provide you with important assets of **high skills and experience** in:

- Systems Engineering (Hardware, Software and Communication)
- Ability to adapt to different protocols (RTU's)
- Conformity and adaptation to international standards
- Design of systems and schemes tailored to the needs of customers
- Prototype design and production
- Testing
- Delivery of finished product – Brand Labelling

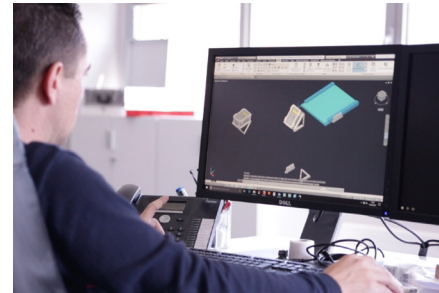

Some of our custom developments:

- Digital controller for fan coil units, which includes power and alarm management functions, which is incorporated in centralized control systems for hotels and large office buildings through Modbus communication protocol.
- Control equipment for electric transformer substations, which set levels of communication speed and immunity to external disturbances beyond the reach of any industrial PLC.
- Load limiter for lifting systems being used by leading manufacturers of overhead cranes and lifting platforms.
- Control and management of SF6 Switchgear for high/medium voltage substations.
- 3-Phase distribution line switch disconnection with incorporated Electronic Sectionaliser
- Fault passage detection system and geographical location of power failures in the section between an electrical substation and the consumer. Designed to detect faults in medium and high voltage, with remote real-time indication at Control Centre.
- Management Systems for Zigbee Communication protocols.



Our work is based on commitment. Reliability is the result.



Underwriters
Laboratories



KEMA Labs



AUSTRIAN INSTITUTE
OF TECHNOLOGY

The quality of all of our products has been certificated by independent & recognized laboratories, and approved in several Electrical Utilities around the world.

The quality of our products and services are in line with international standards.



INTERNATIONAL
ELECTROTECHNICAL
COMMISSION

100% of Fanox Relays are quality tested several times throughout the production process.

IQNET awarded the QUALITY MANAGEMENT SYSTEM, certificate in 1993 – ISO 9001:2008





More than 200.000 Self powered Relays in the field

FANOX

Safely protected

Parque Tecnológico de Bizkia
Astondo bidea, Edificio 604
48160 DERIO (Spain)
tel.: (+34) 94 471 14 09

fanox@fanox.com
www.fanox.com

